



# VISION trimline

2021 - 2022 EDITION





# WELCOME.

The ability to control fire was a dramatic change in the development of humanity. Among many things it provided warmth, light and security. We believe this base connection still exists and is the reason why we still desire to use the fireplace as the central focal point of our living space.

The Vision Trimline range has been designed with the specific purpose of recreating that instinctive connectivity with nature.

Our innovative fires are skilfully engineered to allow a true trimless aspect with no distracting frames or visible workings, just fire. These highly efficient beautifully designed appliances are available in a variety of different sizes and can be positioned in virtually any part of your home.

myfire° | MERTIK MAXITROL° | thermoCet



# CONTENTS.







74 PANORAMIC



88 SLIMLINE



108 CONVENTIONAL FLUE



102 TRIMMED



120 EXTRAS



122 FLUE

---

# TRIMLESS.

Our Trimless fires are designed to be positioned beautifully into integrated walls or retrofitted into existing chimneys. These highly efficient innovative gas fires are skilfully engineered allowing a truly trimless aspect. This means no distracting frames or visible mechanical workings, just fire.

With a choice of either landscape or portrait versions there is an option to suit all interiors. Meticulous attention has been paid to the fuel bed and flame patterns to ensure a perfect recreation of a natural, living fire, with large glass panes to allow unrestricted views.

---











# TL38 TRIMLESS.

The TL38 Trimless balanced flue fire is one of the smaller appliances within the range, making even the smallest rooms feel cosy and inviting. It creates a luxury ambience with a single press of a button. With its realistic fuel bed and flame pattern, it makes a perfect choice for smaller properties.

## WHAT'S INCLUDED.

- High Definition Logs
- Single Burner
- Lamel Chamber
- Ecomax Remote Control
- Convection Vents
- Adjustable Legs
- Gas Control Box

## OPTIONAL EXTRAS.

- Pebbles
- WiFi Kit
- Anti-Reflective Glass
- Remote Control Wall Mount
- Wall Switch
- Mains Adaptor
- Domotica Control

## TECHNICAL INFO.

GAS TYPE	NG	LPG
HEAT INPUT (kW)	6.4	6.2
HEAT OUTPUT MAX (kW)	5.2	5.2
HEAT OUTPUT MIN (kW)	2.8	2.5
EFFICIENCY (%)*	82	84
FLUE SIZE (MM)	100/150	
ERP RATING	B	B

## DIMENSIONS.

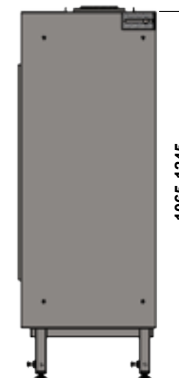
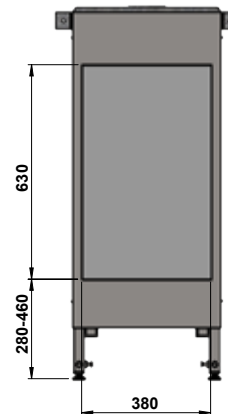
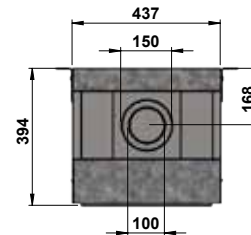

## ALSO AVAILABLE IN.



CORNER  
PAGE 44



QUARTZ  
PAGE 68



PANORAMIC  
PAGE 76



# TL46 TRIMLESS.

The perfectly stylish sleek lines of the TL46 gives this smaller sized fire the effects of a larger fire making it perfect for those with smaller properties. The standard version comes complete with high-definition logs and a smooth steel interior.

## WHAT'S INCLUDED.

- High Definition Logs
- Single Burner
- Flat Steel Chamber
- Ecomax Remote Control
- Convection Vents
- Adjustable Legs
- Gas Control Box

## OPTIONAL EXTRAS.

- WiFi Kit
- Remote Control Wall Mount
- Wall Switch
- Mains Adaptor
- Domotica Control

## TECHNICAL INFO.

GAS TYPE	NG	LPG
HEAT INPUT (kW)	6.6	6.8
HEAT OUTPUT MAX (kW)	5.7	5.8
HEAT OUTPUT MIN (kW)	2.5	2.6
EFFICIENCY (%)*	86	86
FLUE SIZE (MM)	100/150	
ERP RATING	B	B

## DIMENSIONS.

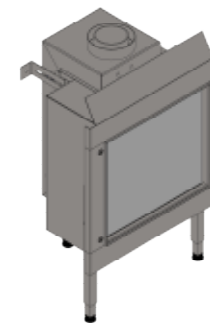
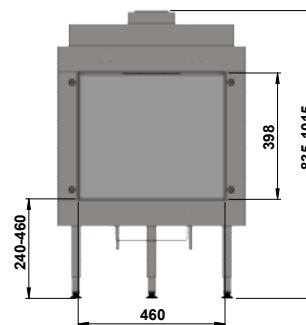
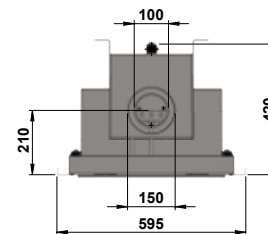





# TL63BL TRIMLESS.

Look no further than the TL63BL trimless which will fit perfectly with virtually all interiors. The large glass front allows unrestricted views of the beautiful flames. The TL63BL incorporates the latest burning log technology. This innovative feature is so realistic it cannot be distinguished from a natural living fire. With the addition of the optional glowing fuel bed, it creates a beautiful warm ambience.

## WHAT'S INCLUDED.

- Burning Log Fuel Bed
- Double Burner
- Flat Steel Chamber
- Ecomax Remote Control
- Convection Vents
- Adjustable Legs
- Gas Control Box

## OPTIONAL EXTRAS.

- Interior Grey Brick Chamber
- Black Groove Chamber
- Black Glass Panel
- LED Glowing Fuel Bed
- WiFi Kit
- Anti-Reflective Glass
- Remote Control Wall Mount
- Wall Switch
- Mains Adaptor
- Wall Bracket
- Domotica Control
- Wide Trims

## TECHNICAL INFO.

GAS TYPE	NG	LPG
HEAT INPUT (kW)	9.5	11.2
HEAT OUTPUT MAX (kW)	7.5	8.8
HEAT OUTPUT MIN (kW)	3.2	2.8
EFFICIENCY (%)*	80	80
FLUE SIZE (MM)	130/200	
ERP RATING	B	B

## ALSO AVAILABLE IN.



CORNER  
PAGE 46

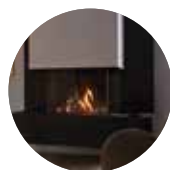

PANORAMIC  
PAGE 78

## DIMENSIONS.

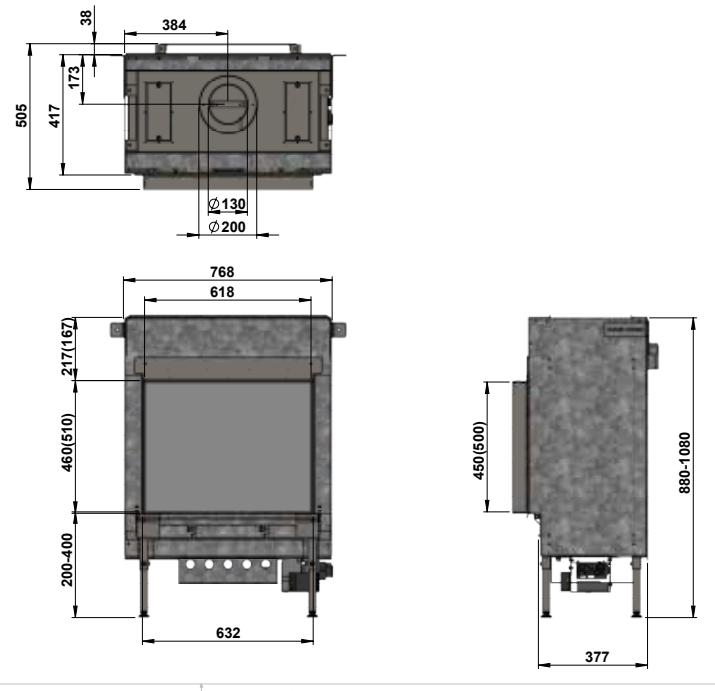



# TL73 TRIMLESS.

The TL73 trimless allows you to create a minimalist look which will fit perfectly with virtually all interiors. The wide glass front allows unrestricted views of the beautiful flames.

## WHAT'S INCLUDED.

- High Definition Logs
- Double Burner
- Lamel Chamber
- Ecomax Remote Control
- Convection Vents
- Adjustable Legs
- Gas Control Box

## OPTIONAL EXTRAS.

- Pebbles
- WiFi Kit
- Anti-Reflective Glass
- Remote Control Wall Mount
- Wall Switch
- Mains Adaptor
- Domotica Control
- Wide Trims

## TECHNICAL INFO.

GAS TYPE	NG	LPG
HEAT INPUT (kW)	11.4	8.8
HEAT OUTPUT MAX (kW)	10.1	7.6
HEAT OUTPUT MIN (kW)	3.1	2.6
EFFICIENCY (%)*	89	86
FLUE SIZE (MM)	130/200	
ERP RATING	A	B

## DIMENSIONS.

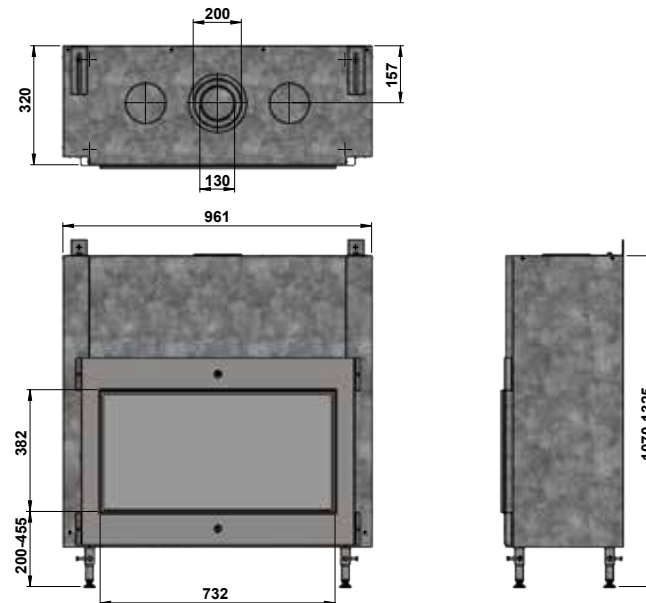





# TL73H TRIMLESS.

The TL73H trimless allows you to create a minimalist look which will fit perfectly with virtually all interiors. The large glass front allows unrestricted views of the beautiful flames.

## WHAT'S INCLUDED.

- High Definition Logs
- Double Burner
- Flat Steel Chamber
- Ecomax Remote Control
- Convection Vents
- Adjustable Legs
- Gas Control Box

## OPTIONAL EXTRAS.

- Pebbles
- Black Glass Panel
- Lamel Chamber
- Deco Brick Chamber
- Deco Tile Chamber
- Interior Grey Brick Chamber
- WiFi Kit
- Anti-Reflective Glass
- Remote Control Wall Mount
- Wall Switch
- Mains Adaptor
- Domotica Control
- Wide Trims

## TECHNICAL INFO.

GAS TYPE	NG	LPG
HEAT INPUT (kW)	11.4	8.8
HEAT OUTPUT MAX (kW)	10.1	7.6
HEAT OUTPUT MIN (kW)	3.1	2.6
EFFICIENCY (%)*	89	86
FLUE SIZE (MM)	130/200	
ERP RATING	A	B

## DIMENSIONS.

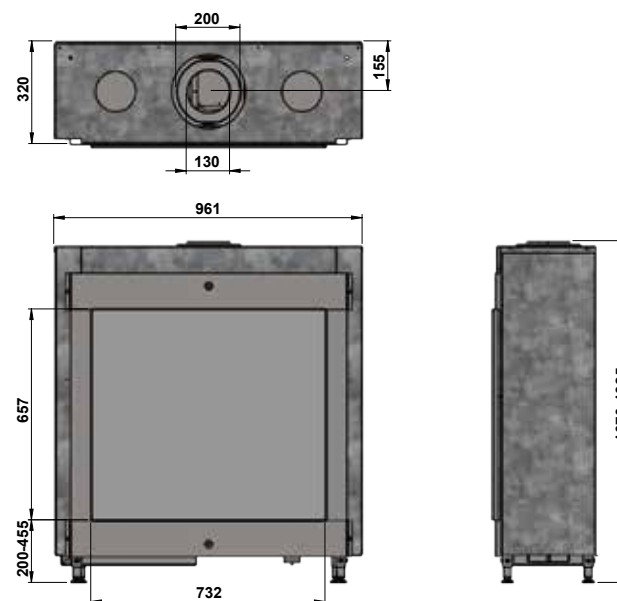

## ALSO AVAILABLE IN.

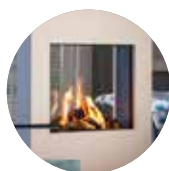

TUNNEL  
PAGE 32



ROOM DIVIDER  
PAGE 60



TRIMMED  
PAGE 102



# TL83 TRIMLESS.

The stunning TL83 available in Trimless, Tunnel, Corner and Panoramic options! The TL83 incorporates the latest burning log technology. This innovative feature is so realistic it cannot be distinguished from a natural living fire. With the addition of the optional glowing fuel bed, it creates a beautiful warm ambience.

## WHAT'S INCLUDED.

- Burning Logs Fuel Bed
- Double Burner
- Flat Steel Chamber
- Ecomax Remote Control
- Convection Vents
- Adjustable Legs
- Gas Control Box

## OPTIONAL EXTRAS.

- Interior Grey Brick Chamber
- Black Groove Chamber
- Black Glass Panel
- LED Glowing Fuel Bed
- WiFi Kit
- Anti-Reflective Glass
- Remote Control Wall Mount
- Wall Switch
- Mains Adaptor
- Wall Bracket
- Leg Extension
- Domotica Control

## TECHNICAL INFO.

GAS TYPE	NG	LPG
HEAT INPUT (kW)	11.5	11.9
HEAT OUTPUT MAX (kW)	9.4	9.8
HEAT OUTPUT MIN (kW)	2.6	2.6
EFFICIENCY (%)*	82	82
FLUE SIZE (MM)	130/200	
ERP RATING	B	B

## DIMENSIONS.

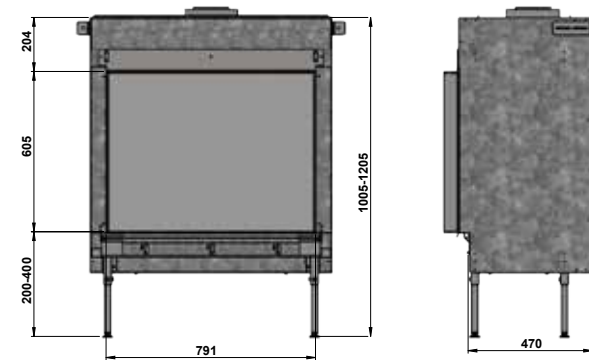
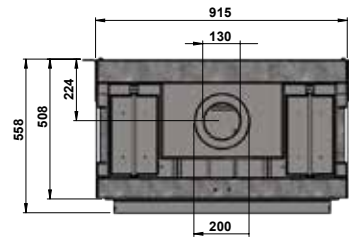

## ALSO AVAILABLE IN.

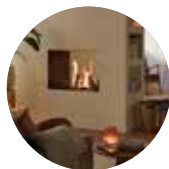

TUNNEL  
PAGE 34



CORNER  
PAGE 48



ROOM DIVIDER  
PAGE 62

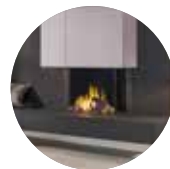

PANORAMIC  
PAGE 80







# TL100 TRIMLESS.

Create a stylish home with the TL100 appliance. It is one of four of the larger elegantly styled landscaped balanced flue gas fires in the Vision Trimline range. The TL100 is all about luxury and suits a wide range of interiors. The double burner creates a beautifully vibrant fire while minimising energy consumption.

## WHAT'S INCLUDED.

- High Definition Logs
- Double Burner
- Lamel Chamber
- Ecomax Remote Control
- Convection Vents
- Adjustable Legs
- Gas Control Box

## OPTIONAL EXTRAS.

- Pebbles
- Carrara
- Basalt
- Black Glass Panel
- WiFi Kit
- Anti-Reflective Glass
- Remote Control Wall Mount
- Wall Switch
- Mains Adaptor
- Domotica Control
- Wide Trims

## TECHNICAL INFO.

GAS TYPE	NG	LPG
HEAT INPUT (kW)	10.2	9.6
HEAT OUTPUT MAX (kW)	8.0	7.4
HEAT OUTPUT MIN (kW)	2.7	3.3
EFFICIENCY (%)*	79	77
FLUE SIZE (MM)	130/200	
ERP RATING	B	B

## DIMENSIONS.

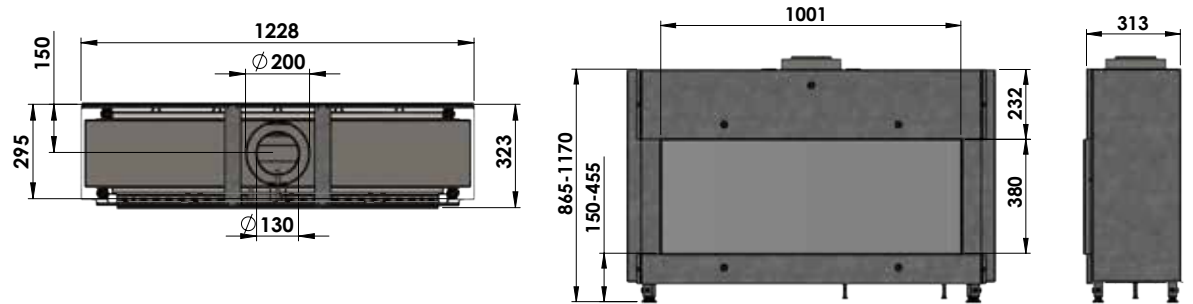

## ALSO AVAILABLE IN.



SILHOUETTE  
PAGE 22

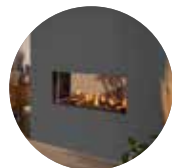

TUNNEL  
PAGE 36



CORNER  
PAGE 50

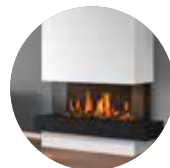

PANORAMIC  
PAGE 82



# TL100 SILHOUETTE.

The TL100 Silhouette features a delicate frame which has been simply styled to retain the contemporary look and feel of the TL100. The TL100 is one of four of the larger elegantly styled landscaped balanced flue gas fires in the Vision Trimline range.

## WHAT'S INCLUDED.

- High Definition Logs
- Double Burner
- Lamel Chamber
- Ecomax Remote Control
- Convection Vents
- Adjustable Legs
- Gas Control Box

## OPTIONAL EXTRAS.

- Pebbles
- Carrara
- Basalt
- Black Glass Panel
- WiFi Kit
- Anti-Reflective Glass
- Remote Control Wall Mount
- Wall Switch
- Mains Adaptor
- Domotica Control

## TECHNICAL INFO.

GAS TYPE	NG	LPG
HEAT INPUT (kW)	10.2	9.6
HEAT OUTPUT MAX (kW)	8.0	7.4
HEAT OUTPUT MIN (kW)	2.7	3.3
EFFICIENCY (%)*	79	77
FLUE SIZE (MM)	130/200	
ERP RATING	B	B

## DIMENSIONS.

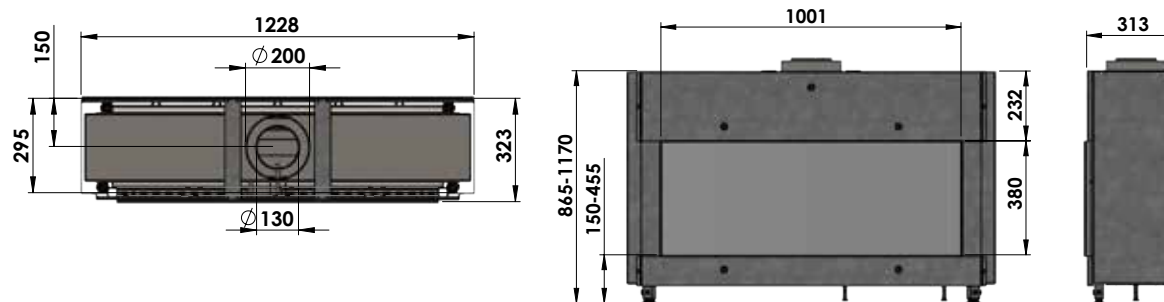

## ALSO AVAILABLE IN.



TRIMLESS  
PAGE 20

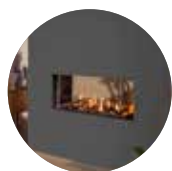

TUNNEL  
PAGE 36



CORNER  
PAGE 50

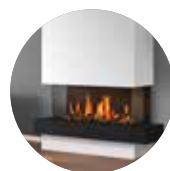

PANORAMIC  
PAGE 82





# TL120 TRIMLESS.

The TL120 is one of four of the larger elegantly styled landscaped balanced flue gas fires in the Vision Trimline range which will fit seamlessly in a range of interiors. It is particularly suited to modern interior design styles. Liven up your home with a single press of a button. The standard version comes complete with high-definition logs and a lamel interior. On top of that, it comes with the Ecomax remote control and you have the options of adding Wi-Fi control with our Trimline Fires app.

## WHAT'S INCLUDED.

- High Definition Logs
- Double Burner
- Lamel Chamber
- Ecomax Remote Control
- Convection Vents
- Adjustable Legs
- Gas Control Box

## OPTIONAL EXTRAS.

- Pebbles
- Carrara
- Basalt
- Black Glass Panel
- WiFi Kit
- Anti-Reflective Glass
- Remote Control Wall Mount
- Wall Switch
- Mains Adaptor
- Domotica Control
- Wide Trims

## TECHNICAL INFO.

GAS TYPE	NG	LPG
HEAT INPUT (kW)	12.8	10.2
HEAT OUTPUT MAX (kW)	10.1	8.0
HEAT OUTPUT MIN (kW)	4.6	3.6
EFFICIENCY (%)*	79	78
FLUE SIZE (MM)	130/200	
ERP RATING	B	B

## DIMENSIONS.

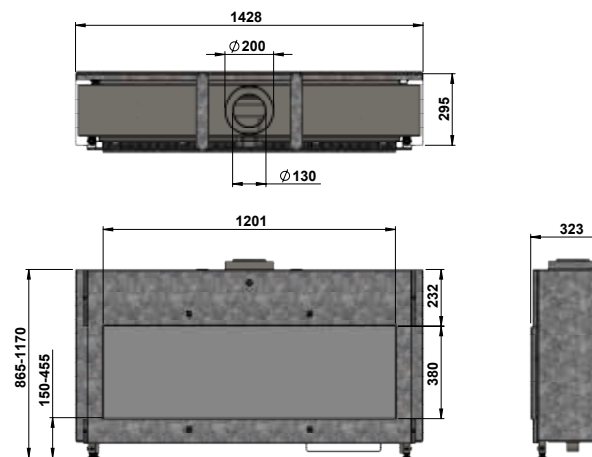

## ALSO AVAILABLE IN.

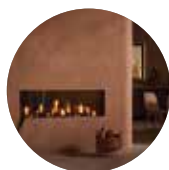

TUNNEL  
PAGE 38

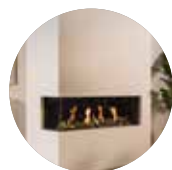

CORNER  
PAGE 52



PANORAMIC  
PAGE 84



# TL140 TRIMLESS.

Are you looking for an extra little something? Add a touch of elegance and luxury with the TL140. The standard version of this appliance comes with high-definition logs which creates beautifully vibrant flames while limiting the amount of heat generated. On top of that, it comes with the Ecomax remote control and you have the options of adding Wi-Fi-control with our Trimline Fires app.

## WHAT'S INCLUDED.

- High Definition Logs
- Double Burner
- Lamel Chamber
- Ecomax Remote Control
- Convection Vents
- Adjustable Legs
- Gas Control Box

## OPTIONAL EXTRAS.

- Pebbles
- Carrara
- Basalt
- Black Glass Panel
- WiFi Kit
- Anti-Reflective Glass
- Remote Control Wall Mount
- Wall Switch
- Mains Adaptor
- Domotica Control
- Wide Trims

## TECHNICAL INFO.

GAS TYPE	NG	LPG
HEAT INPUT (kW)	13.8	12.7
HEAT OUTPUT MAX (kW)	11.0	10.2
HEAT OUTPUT MIN (kW)	4.5	3.9
EFFICIENCY (%)*	80	81
FLUE SIZE (MM)	130/200	
ERP RATING	B	B

## DIMENSIONS.

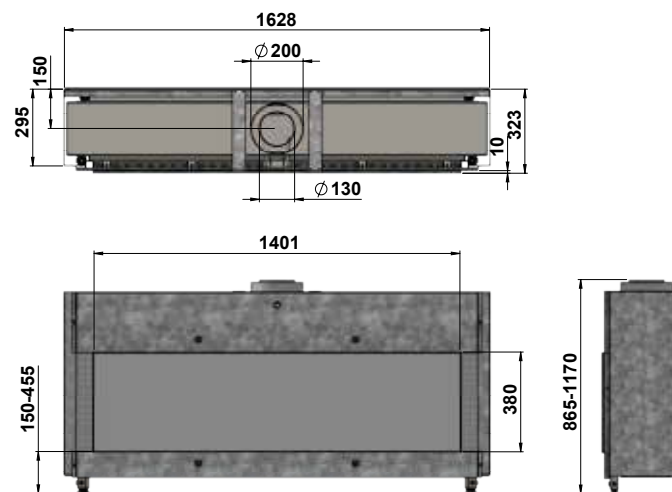

## ALSO AVAILABLE IN.



TUNNEL  
PAGE 40



CORNER  
PAGE 54



PANORAMIC  
PAGE 88







# TL170 TRIMLESS.

The TL170 is one of four of the larger elegantly styled landscaped balanced flue gas fires in the Vision Trimline range. This gas fire will add a touch of elegance and sophistication to any room. This innovative fire is skilfully engineered to allow a truly trimless fire. Meticulous attention has been paid to the realisation of the fuel bed and flame patterns to ensure a perfect recreation of a natural living fire.

## WHAT'S INCLUDED.

- High Definition Logs
- Double Burner
- Lamel Chamber
- Ecomax Remote Control
- Convection Vents
- Adjustable Legs
- Gas Control Box

## OPTIONAL EXTRAS.

- Pebbles
- Carrara
- Basalt
- Black Glass Panel
- WiFi Kit
- Anti-Reflective Glass
- Remote Control Wall Mount
- Wall Switch
- Mains Adaptor
- Domotica Control
- Wide Trims

## TECHNICAL INFO.

GAS TYPE	NG	LPG
HEAT INPUT (kW)	15.3	15.1
HEAT OUTPUT MAX (kW)	12.0	12.4
HEAT OUTPUT MIN (kW)	3.5	3.0
EFFICIENCY (%)*	82	82
FLUE SIZE (MM)	130/200	
ERP RATING	B	B

## DIMENSIONS.

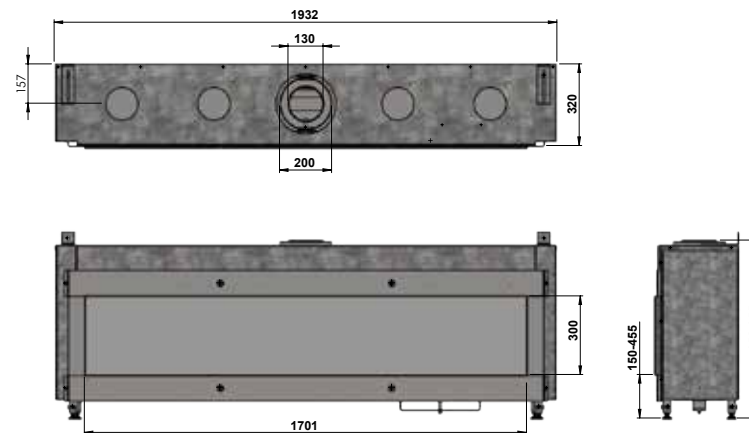

# TUNNEL.

A tunnel fireplace serves as the focus point of any room. It is a statement that draws everyone's eyes, without overshadowing the rest of the decor. In fact, it elevates the entire room. Trimline Fires fireplaces fit with any personal style and any decor. Tunnel fires are two sided appliances that allow you to enjoy the beautiful flames and warmth from two rooms at once! They are perfect for modern open plan homes and can be used to connect spaces, allowing you to see into adjoining rooms, connecting not just rooms, but people as well. Make your house feel like a real home with this luxurious addition.









# TL73HT TUNNEL.

A tunnel fireplace serves as the focus point of any room. It is a statement that draws everyone's eyes, without overshadowing the rest of the decor. In fact, it elevates the entire room. The TL73HT Tunnel is the smallest of the tunnel fires in the Vision Trimline range and allows you to view the fire from two rooms at once! Perfect for a modern open plan home or a beautiful room divider.

## WHAT'S INCLUDED.

- High Definition Logs
- Double Burner
- Flat Steel Chamber
- Ecomax Remote Control
- Convection Vents
- Adjustable Legs
- Gas Control Box

## OPTIONAL EXTRAS.

- Pebbles
- WiFi Kit
- Anti-Reflective Glass
- Remote Control Wall Mount
- Wall Switch
- Mains Adaptor
- Domotica Control
- Wide Trims

## TECHNICAL INFO.

GAS TYPE	NG	LPG
HEAT INPUT (kW)	11.4	8.8
HEAT OUTPUT MAX (kW)	10.1	7.6
HEAT OUTPUT MIN (kW)	3.1	2.6
EFFICIENCY (%)*	89	86
FLUE SIZE (MM)	130/200	
ERP RATING	A	B

## DIMENSIONS.

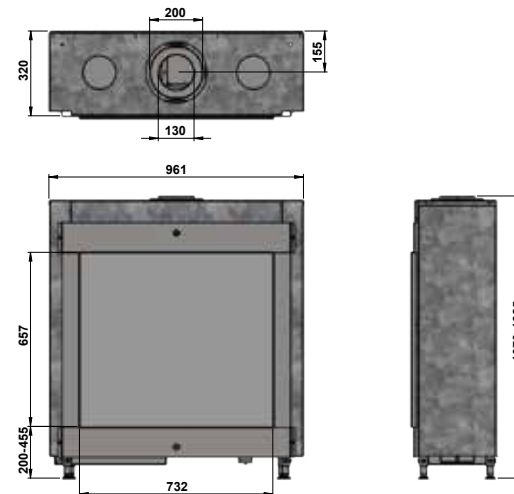

## ALSO AVAILABLE IN.



TRIMLESS  
PAGE 16



ROOM DIVIDER  
PAGE 60



TRIMMED  
PAGE 102



# TL83T TUNNEL.

The TL83 Tunnel is the smallest of the landscape tunnel fires offered in the Vision Trimline range. It allows you to view the fire from two rooms at once! Perfect for a modern open plan home or a beautiful room divider.

## WHAT'S INCLUDED.

- Burning Logs Fuel Bed
- Double Burner
- Flat Steel Chamber
- Ecomax Remote Control
- Convection Vents
- Adjustable Legs
- Gas Control Box

## OPTIONAL EXTRAS.

- Black Glass Panel
- Black Groove Chamber
- LED Glowing Fuel Bed
- WiFi Kit
- Wall Bracket
- Anti-Reflective Glass
- Remote Control Wall Mount
- Wall Switch
- Mains Adaptor
- Domotica Control

## TECHNICAL INFO.

GAS TYPE	NG	LPG
HEAT INPUT (kW)	12.2	13.9
HEAT OUTPUT MAX (kW)	10.2	11.5
HEAT OUTPUT MIN (kW)	3.7	3.5
EFFICIENCY (%)*	83	83
FLUE SIZE (MM)	130/200	
ERP RATING	B	B

## DIMENSIONS.

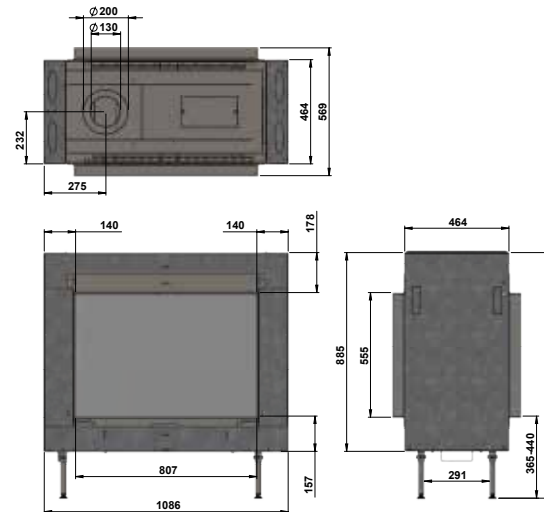

## ALSO AVAILABLE IN.

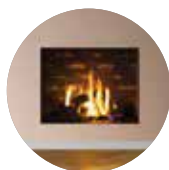

TRIMLESS  
PAGE 18



CORNER  
PAGE 48



ROOM DIVIDER  
PAGE 62

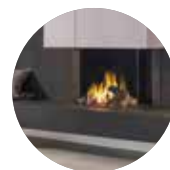

PANORAMIC  
PAGE 80





# TL100T TUNNEL.

Tunnel fireplaces make for a particularly stylish addition to your interior. They are perfect for connecting rooms alternatively they make a beautiful room divider allowing you to view the fire from 2 rooms at once! The double burner will create a beautifully vibrant fire while minimising energy consumption. The TL100 Tunnel is the most compact tunnel fireplace available in a landscape version.

## WHAT'S INCLUDED.

- High Definition Logs
- Double Burner
- Flat Steel Chamber
- Ecomax Remote Control
- Convection Vents
- Adjustable Legs
- Gas Control Box

## OPTIONAL EXTRAS.

- Pebbles
- Carrara
- Basalt
- WiFi Kit
- Anti-Reflective Glass
- Remote Control Wall Mount
- Wall Switch
- Mains Adaptor
- Domotica Control
- Wide Trims

## TECHNICAL INFO.

GAS TYPE	NG	LPG
HEAT INPUT (kW)	10.2	9.6
HEAT OUTPUT MAX (kW)	8.0	7.4
HEAT OUTPUT MIN (kW)	2.7	3.3
EFFICIENCY (%)*	79	77
FLUE SIZE (MM)	130/200	
ERP RATING	B	B

## DIMENSIONS.

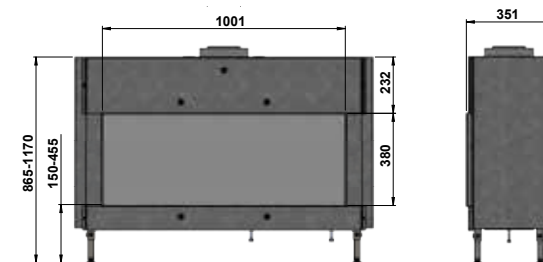
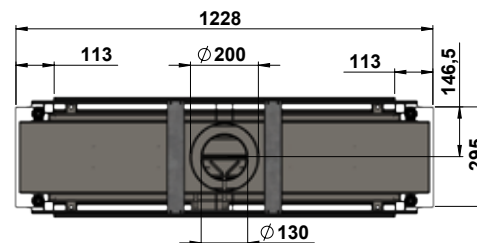

## ALSO AVAILABLE IN.



TRIMLESS  
PAGE 20



SILHOUETTE  
PAGE 22



CORNER  
PAGE 50

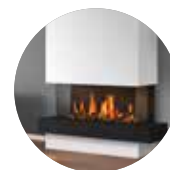

PANORAMIC  
PAGE 82





# TL120T TUNNEL.

Create a statement with the stunning TL120 Tunnel, this appliance is the perfect way to connect spaces, allowing you to see into adjoining rooms. It is the perfect statement piece for your home, connecting not just rooms, but people as well. Make your house feel like a real home with this luxurious addition. The TL120 Tunnel is perfect for lots of different homes, not just in terms of its looks, but also its size. It is a medium sized gas fireplace that also comes in corner, panoramic or trimless options.

## WHAT'S INCLUDED.

- High Definition Logs
- Double Burner
- Flat Steel Chamber
- Ecomax Remote Control
- Convection Vents
- Adjustable Legs
- Gas Control Box

## OPTIONAL EXTRAS.

- Pebbles
- Carrara
- Basalt
- WiFi Kit
- Anti-Reflective Glass
- Remote Control Wall Mount
- Wall Switch
- Mains Adaptor
- Domotica Control
- Wide Trims

## TECHNICAL INFO.

GAS TYPE	NG	LPG
HEAT INPUT (kW)	12.8	10.2
HEAT OUTPUT MAX (kW)	10.1	8.0
HEAT OUTPUT MIN (kW)	4.6	3.6
EFFICIENCY (%)*	79	78
FLUE SIZE (MM)	130/200	
ERP RATING	B	B

## DIMENSIONS.

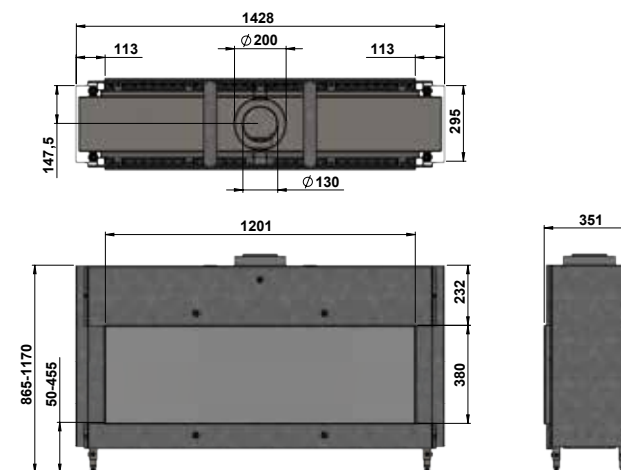

## ALSO AVAILABLE IN.



TRIMLESS  
PAGE 24



CORNER  
PAGE 52



PANORAMIC  
PAGE 84



# TL140T TUNNEL.

The TL140T Tunnel is the largest tunnel fires offered in the Vision Trimline range. It allows you to view the fire from two rooms at once! Perfect for a modern open plan home or a beautiful room divider.

## WHAT'S INCLUDED.

- High Definition Logs
- Double Burner
- Flat Steel Chamber
- Ecomax Remote Control
- Convection Vents
- Adjustable Legs
- Gas Control Box

## OPTIONAL EXTRAS.

- Pebbles
- Carrara
- Basalt
- WiFi Kit
- Anti-Reflective Glass
- Remote Control Wall Mount
- Wall Switch
- Mains Adaptor
- Domotica Control
- Wide Trims

## TECHNICAL INFO.

GAS TYPE	NG	LPG
HEAT INPUT (kW)	13.8	12.7
HEAT OUTPUT MAX (kW)	11.0	10.2
HEAT OUTPUT MIN (kW)	4.5	3.9
EFFICIENCY (%)*	80	81
FLUE SIZE (MM)	130/200	
ERP RATING	B	B

## DIMENSIONS.

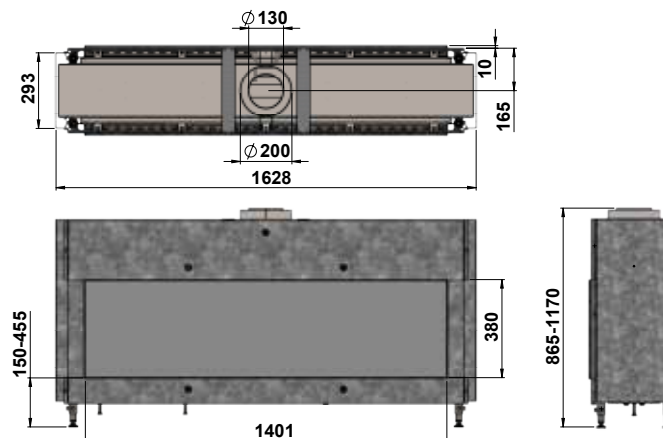

## ALSO AVAILABLE IN.

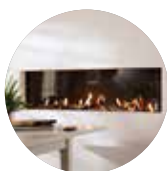

TRIMLESS  
PAGE 26



CORNER  
PAGE 54



PANORAMIC  
PAGE 85



# CORNER.

If you are looking to make a real statement, a corner fire may be the perfect choice. The highly efficient corner fire allows you to view the beautiful flames from different angles and is available in either left-sided or right-sided options.







# TL38C CORNER.

The TL38C can transform the smallest of living spaces into a modern contemporary space. This appliance is a great example of how a small space can be utilised with its realistic fuel bed and flame pattern, it makes a perfect choice for smaller properties.

## WHAT'S INCLUDED.

- High Definition Logs
- Single Burner
- Lamel Chamber
- Ecomax Remote Control
- Convection Vents
- Adjustable Legs
- Gas Control Box

## OPTIONAL EXTRAS.

- Pebbles
- WiFi Kit
- Anti-Reflective Glass
- Remote Control Wall Mount
- Wall Switch
- Mains Adaptor
- Domotica Control
- Wide Trims

## TECHNICAL INFO.

GAS TYPE	NG	LPG
HEAT INPUT (kW)	6.4	6.2
HEAT OUTPUT MAX (kW)	5.2	5.2
HEAT OUTPUT MIN (kW)	2.8	2.5
EFFICIENCY (%)*	82	84
FLUE SIZE (MM)	100/150	
ERP RATING	B	B

## DIMENSIONS.

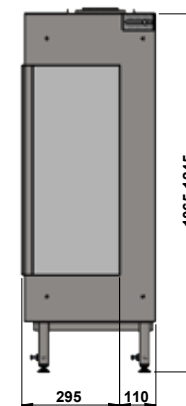
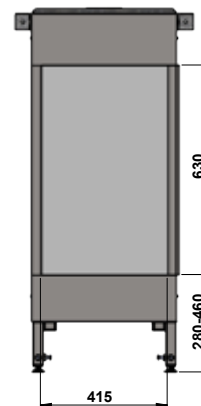
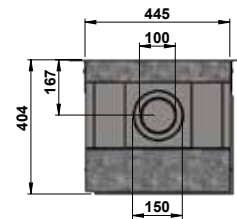

## ALSO AVAILABLE IN.



TRIMLESS  
PAGE 8



QUARTZ  
PAGE 68



PANORAMIC  
PAGE 76







# TL63BL CORNER.

Look no further than the TL63BL Corner which will fit perfectly with virtually all interiors. It can transform the smallest of living spaces into a modern contemporary space. The balanced flue corner gas fire incorporates the latest burning log technology. This innovative feature is so realistic it cannot be distinguished from a natural living fire. With the addition of the optional glowing fuel bed, it creates a beautiful warm ambience!

## WHAT'S INCLUDED.

- Burning Log Fuel Bed
- Double Burner
- Flat Steel Chamber
- Ecomax Remote Control
- Convection Vents
- Adjustable Legs
- Gas Control Box

## OPTIONAL EXTRAS.

- Interior Grey Brick Chamber
- Black Groove Chamber
- Black Glass Panel
- LED Glowing Fuel Bed
- WiFi Kit
- Anti-Reflective Glass
- Remote Control Wall Mount
- Wall Switch
- Mains Adaptor
- Wall Bracket
- Domotica Control
- Wide Trims

## TECHNICAL INFO.

GAS TYPE	NG	LPG
HEAT INPUT (kW)	9.5	11.2
HEAT OUTPUT MAX (kW)	7.5	8.8
HEAT OUTPUT MIN (kW)	3.2	2.8
EFFICIENCY (%)*	80	80
FLUE SIZE (MM)	130/200	
ERP RATING	B	B

## DIMENSIONS.

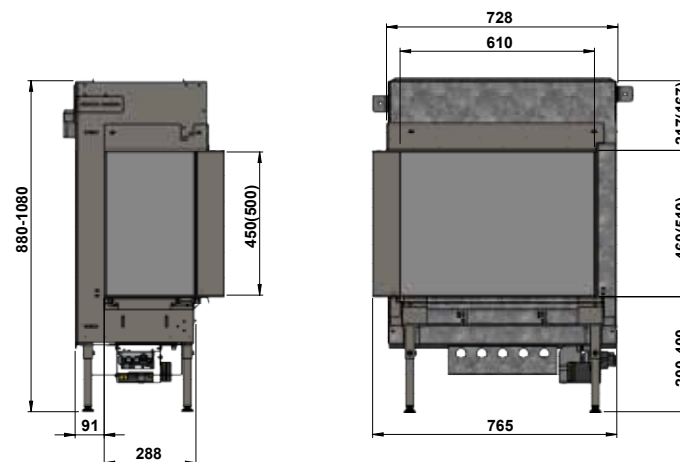
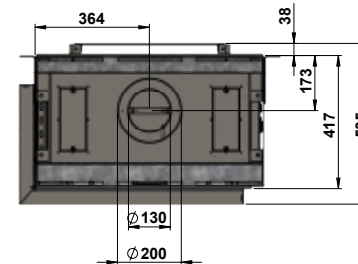

## ALSO AVAILABLE IN.



TRIMLESS  
PAGE 12

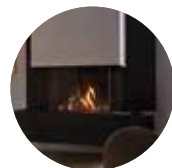

PANORAMIC  
PAGE 78



# TL83C CORNER.

Warmth at the touch of a button with our TL83 Corner. The balanced flue corner gas fire incorporates the latest burning log technology. This innovative feature is so realistic it cannot be distinguished from a natural living fire. With the addition of the optional glowing fuel bed, it creates a beautiful warm ambience!

## WHAT'S INCLUDED.

- Burning Logs Fuel Bed
- Double Burner
- Lamel Chamber
- Ecomax Remote Control
- Convection Vents
- Adjustable Legs
- Gas Control Box

## OPTIONAL EXTRAS.

- Black Glass Panel
- Interior Grey Chamber
- Black Groove Chamber
- LED Glowing Fuel Bed
- WiFi Kit
- Anti-Reflective Glass
- Remote Control Wall Mount
- Wall Switch
- Mains Adaptor
- Wall Bracket
- Leg Extension
- Domotica Control

## TECHNICAL INFO.

GAS TYPE	NG	LPG
HEAT INPUT (kW)	11.5	11.9
HEAT OUTPUT MAX (kW)	9.4	9.8
HEAT OUTPUT MIN (kW)	2.6	2.6
EFFICIENCY (%)*	82	82
FLUE SIZE (MM)	130/200	
ERP RATING	B	B

## DIMENSIONS.

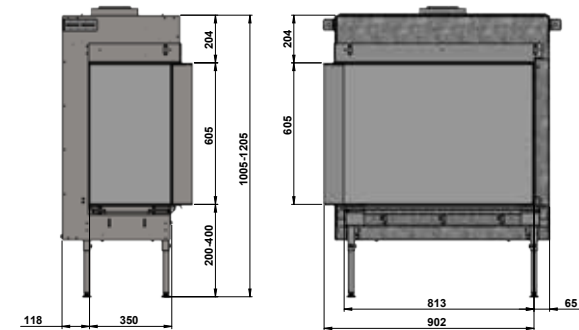
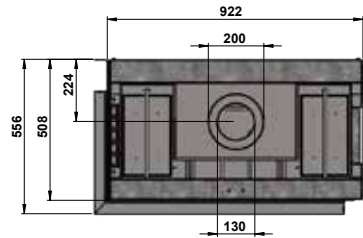

## ALSO AVAILABLE IN.

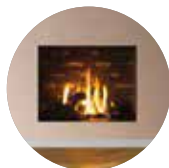

TRIMLESS  
PAGE 18



TUNNEL  
PAGE 34



ROOM DIVIDER  
PAGE 62



PANORAMIC  
PAGE 80





# TL100C CORNER.

If you are looking for corner fireplaces that can really take centre stage then look no further than the TL100 Corner. With this wide corner fireplace, enjoyment takes on a different dimension.

## WHAT'S INCLUDED.

- High Definition Logs
- Double Burner
- Lamel Chamber
- Ecomax Remote Control
- Convection Vents
- Adjustable Legs
- Gas Control Box

## OPTIONAL EXTRAS.

- Pebbles
- Carrara
- Basalt
- Black Glass Panel
- WiFi Kit
- Remote Control Wall Mount
- Wall Switch
- Mains Adaptor
- Domotica Control
- Wide Trims

## TECHNICAL INFO.

GAS TYPE	NG	LPG
HEAT INPUT (kW)	11.2	9.7
HEAT OUTPUT MAX (kW)	9.4	8.1
HEAT OUTPUT MIN (kW)	2.9	3.6
EFFICIENCY (%)*	84	84
FLUE SIZE (MM)	130/200	
ERP RATING	B	B

## DIMENSIONS.

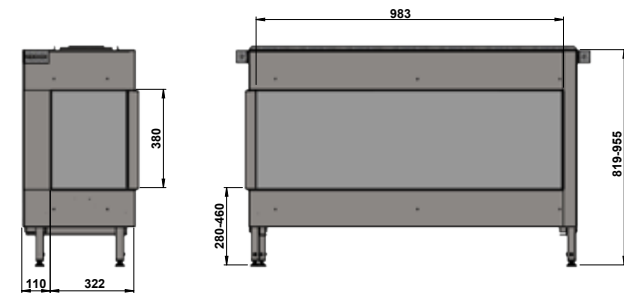
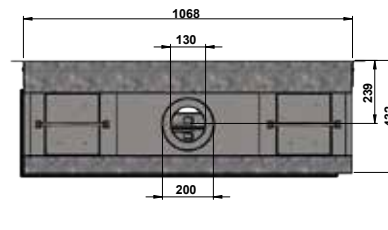

## ALSO AVAILABLE IN.



TRIMLESS  
PAGE 20



SILHOUETTE  
PAGE 22

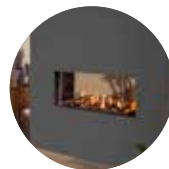

TUNNEL  
PAGE 36

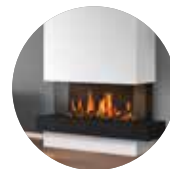

PANORAMIC  
PAGE 82





# TL120C CORNER.

If you are looking for corner fireplaces that can really take centre stage then look no further than the TL120 Corner. With this extra wide corner fireplace, enjoyment takes on a different dimension.

## WHAT'S INCLUDED.

- High Definition Logs
- Double Burner
- Lamel Chamber
- Ecomax Remote Control
- Convection Vents
- Adjustable Legs
- Gas Control Box

## OPTIONAL EXTRAS.

- Pebbles
- Carrara
- Basalt
- Black Glass Panel
- WiFi Kit
- Remote Control Wall Mount
- Wall Switch
- Mains Adaptor
- Domotica Control
- Wide Trims

## TECHNICAL INFO.

GAS TYPE	NG	LPG
HEAT INPUT (kW)	13.1	9.9
HEAT OUTPUT MAX (kW)	10.9	8.1
HEAT OUTPUT MIN (kW)	2.5	2.0
EFFICIENCY (%)*	83	82
FLUE SIZE (MM)	130/200	
ERP RATING	B	B

## DIMENSIONS.

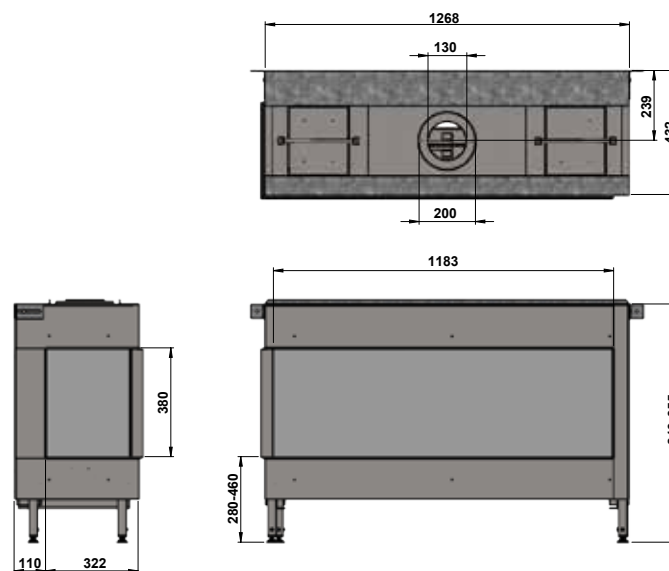

## ALSO AVAILABLE IN.

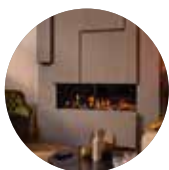

TRIMLESS  
PAGE 24



TUNNEL  
PAGE 38



PANORAMIC  
PAGE 84



# TL140C CORNER.

If you are looking for corner fireplaces that can really take centre stage then look no further than the TL140 Corner. This is the widest corner fireplace in the range, ensuring enjoyment takes on a different dimension.

## WHAT'S INCLUDED.

- High Definition Logs
- Double Burner
- Lamel Chamber
- Ecomax Remote Control
- Convection Vents
- Adjustable Legs
- Gas Control Box

## OPTIONAL EXTRAS.

- Pebbles
- Carrara
- Basalt
- Black Glass Panel
- WiFi Kit
- Remote Control Wall Mount
- Wall Switch
- Mains Adaptor
- Domotica Control
- Wide Trims

## TECHNICAL INFO.

GAS TYPE	NG	LPG
HEAT INPUT (kW)	14.5	12.4
HEAT OUTPUT MAX (kW)	12.0	10.6
HEAT OUTPUT MIN (kW)	3.0	3.0
EFFICIENCY (%)*	83	86
FLUE SIZE (MM)	130/200	
ERP RATING	B	B

## ALSO AVAILABLE IN.



TRIMLESS  
PAGE 26

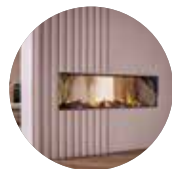

TUNNEL  
PAGE 40



PANORAMIC  
PAGE 85

## DIMENSIONS.

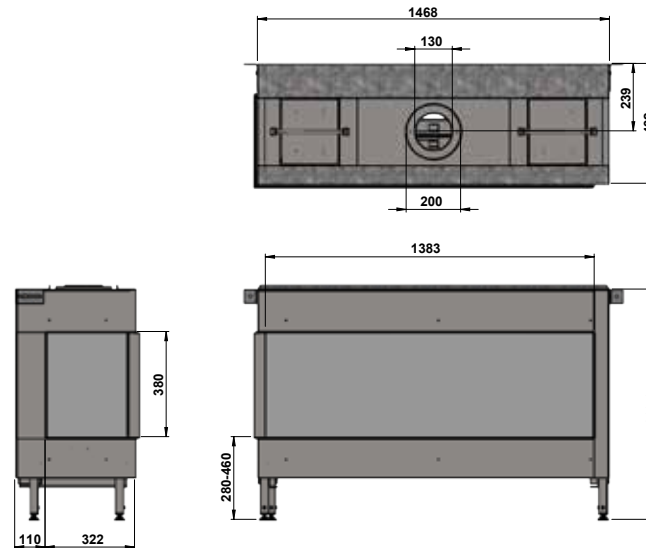





# TL2050 ON THE CORNER

Are you looking for a unique look? The stylish TL2050 On The Corner will turn your L-shaped living room into a work of art. Light up your life with this fireplace and will make the room come alive with the single push of a button.

## WHAT'S INCLUDED.

- High Definition Logs
- Single Burner
- Flat Steel Chamber
- Ecomax Remote Control
- Convection Vents
- Adjustable Legs
- Gas Control Box

## OPTIONAL EXTRAS.

- WiFi Kit
- Anti-Reflective Glass
- Remote Control Wall Mount
- Wall Switch
- Mains Adaptor
- Domotica Control

## TECHNICAL INFO.

GAS TYPE	NG	LPG
HEAT INPUT (kW)	8.7	8.2
HEAT OUTPUT MAX (kW)	7.3	6.8
HEAT OUTPUT MIN (kW)	2.8	2.5
EFFICIENCY (%)*	84	83
FLUE SIZE (MM)	100/150	
ERP RATING	B	B

## DIMENSIONS.

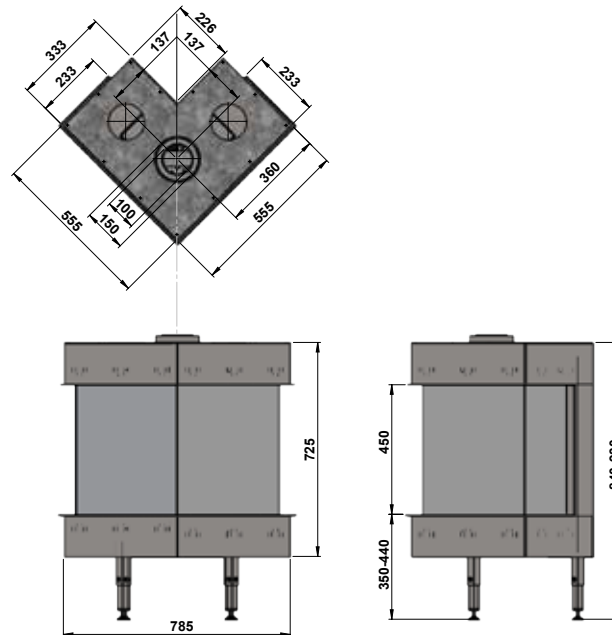

# ROOM DIVIDER.

Who says an efficient solution cannot be stylish at the same time? Get the best of both worlds with a room divider that does it all. A room divider fireplace allows you to stylishly partition a room allowing you to enjoy the cosy comfort of your fire from different aspects, or even different rooms.









# TL73RD ROOM DIVIDER.

The stylish TL73RD is a unique three sided fire ideal for splitting up a space that allows the flames to be enjoyed from all sides of the room. This room divider fireplace is beautifully tall, and also narrow enough to still be practical. It's the perfect room divider!

## WHAT'S INCLUDED.

- High Definition Logs
- Double Burner
- Flat Steel Chamber
- Ecomax Remote Control
- Convection Vents
- Adjustable Legs
- Gas Control Box

## OPTIONAL EXTRAS.

- Pebbles
- WiFi Kit
- Anti-Reflective Glass
- Remote Control Wall Mount
- Wall Switch
- Mains Adaptor
- Domotica Control
- Wide Trims

## TECHNICAL INFO.

GAS TYPE	NG	LPG
HEAT INPUT (kW)	11.4	8.8
HEAT OUTPUT MAX (kW)	10.1	7.6
HEAT OUTPUT MIN (kW)	3.1	2.6
EFFICIENCY (%)*	89	86
FLUE SIZE (MM)	130/200	
ERP RATING	A	B

## DIMENSIONS.

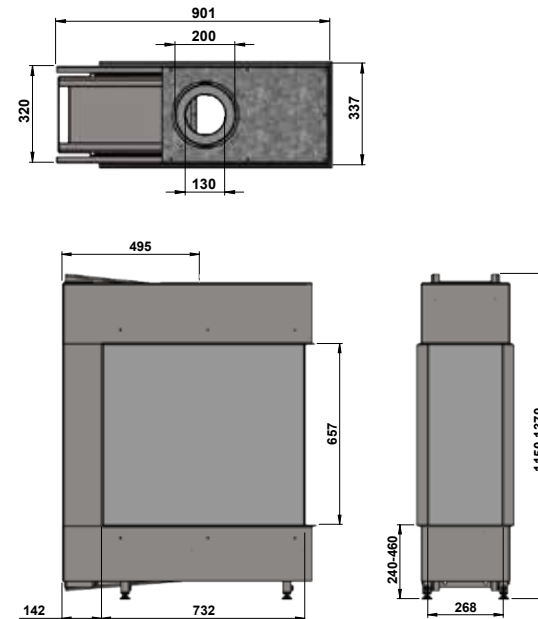

## ALSO AVAILABLE IN.

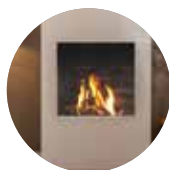

TRIMLESS  
PAGE 16

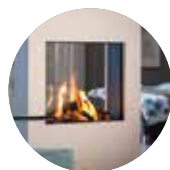

TUNNEL  
PAGE 32



TRIMMED  
PAGE 102



# TL83 ROOM DIVIDER.

The stunning TL83 Room Divider is also available in Trimless, Corner and Panoramic options! This appliance incorporates the latest burning log technology. This innovative feature is so realistic it cannot be distinguished from a natural living fire. With the addition of the optional glowing fuel bed, it creates a beautiful warm ambience!

## WHAT'S INCLUDED.

- High Definition Logs
- Double Burner
- Flat Steel Chamber
- Ecomax Remote Control
- Convection Vents
- Adjustable Legs
- Gas Control Box

## OPTIONAL EXTRAS.

- Black Groove Chamber
- Black Glass Panel
- LED Glowing Fuel Bed
- WiFi Kit
- Wall Bracket
- Anti-Reflective Glass
- Remote Control Wall Mount
- Wall Switch
- Mains Adaptor
- Domotica Control

## TECHNICAL INFO.

GAS TYPE	NG	LPG
HEAT INPUT (kW)	12.2	13.9
HEAT OUTPUT MAX (kW)	10.2	11.5
HEAT OUTPUT MIN (kW)	3.7	3.5
EFFICIENCY (%)*	83	83
FLUE SIZE (MM)	130/200	
ERP RATING	B	B

## DIMENSIONS.

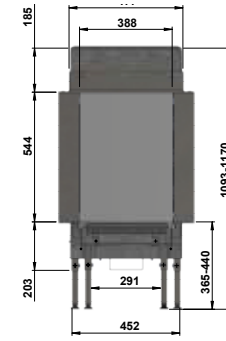
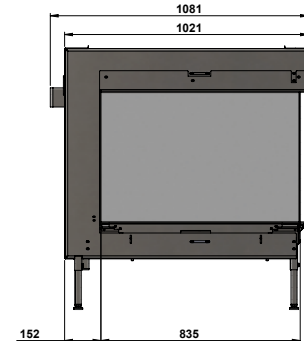
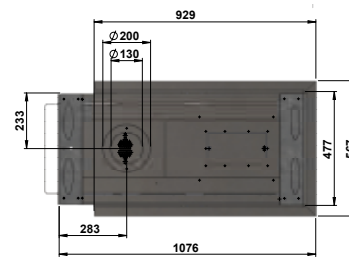

## ALSO AVAILABLE IN.

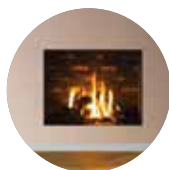

TRIMLESS  
PAGE 18

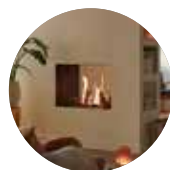

TUNNEL  
PAGE 34

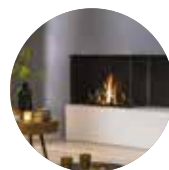

CORNER  
PAGE 48

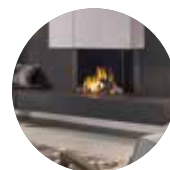

PANORAMIC  
PAGE 80





# TL85 ROOM DIVIDER.

Our state of the art TL85 landscape room divider will create an impact in any living space. This three-sided gas appliance can also be used between multiple rooms allowing you to view the fire from all three sides.

## WHAT'S INCLUDED.

- High Definition Logs
- Single Burner
- Lamel Chamber
- Ecomax Remote Control
- Convection Vents
- Adjustable Legs
- Gas Control Box

## OPTIONAL EXTRAS.

- Pebbles
- Carrara
- Basalt
- WiFi Kit
- Wall Bracket
- Anti-Reflective Glass
- Remote Control Wall Mount
- Wall Switch
- Mains Adaptor
- Domotica Control
- Wide Trims

## TECHNICAL INFO.

GAS TYPE	NG	LPG
HEAT INPUT (kW)	9.9	8.9
HEAT OUTPUT MAX (kW)	8.1	7.3
HEAT OUTPUT MIN (kW)	3.0	2.5
EFFICIENCY (%)*	82	82
FLUE SIZE (MM)	130/200	
ERP RATING	B	B

## DIMENSIONS.

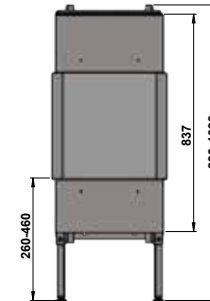
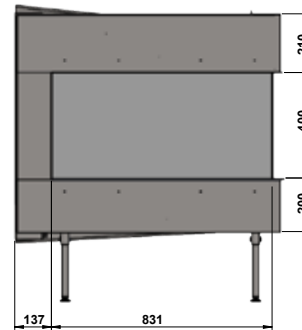
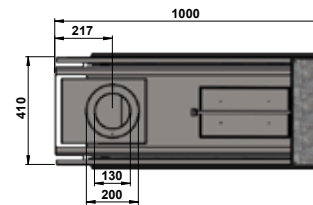

---

# GEMSTONE SERIES.

At night, your fireplace's silhouette steals the show as the backdrop to its own flames. Light the fire and enjoy the luxurious ambience created.







# TRIMLINE QUARTZ.

The Trimline Quartz is proof you do not need a large home to have a freestanding gas fireplace. This is a beautiful, very lavish freestanding eyecatcher, adding special ambience to any room.

## WHAT'S INCLUDED.

- High Definition Logs
- Single Burner
- Lamel Chamber
- Ecomax Remote Control

## OPTIONAL EXTRAS.

- Anti-Reflective Glass
- Mains Adaptor
- Wall Switch
- Wifi Kit
- Remote Control Wall Mount
- Domotica Control

## TECHNICAL INFO.

GAS TYPE	NG	LPG
HEAT INPUT (kW)	6.4	6.2
HEAT OUTPUT MAX (kW)	5.2	5.2
HEAT OUTPUT MIN (kW)	2.8	2.5
EFFICIENCY (%)*	82	84
FLUE SIZE (MM)	100/150	
ERP RATING	B	B

## DIMENSIONS.

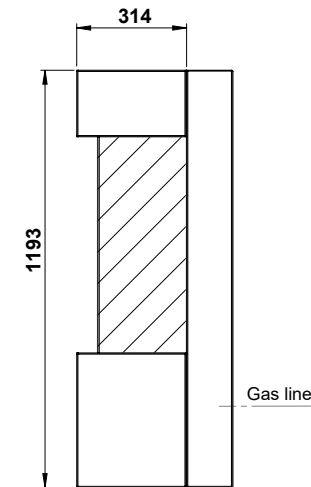
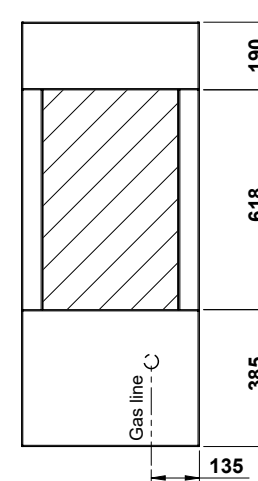
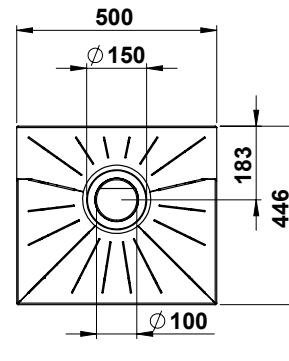

## ALSO AVAILABLE IN.



TRIMLESS  
PAGE 8



CORNER  
PAGE 44



ZIRCON  
PAGE 70



TOURMALINE  
PAGE 72



PANORAMIC  
PAGE 76



# TRIMLINE ZIRCON.

The Zircon trimline is our smallest freestanding fire. Unique in its kind. Like small gemstones dazzling in its beauty. The rounded corners and its open character give the fireplace a playful appearance. Create your own unique look. For a whimsical touch, add wooden blocks to the open bottom. The possibilities are endless. Try and discover your unique fireplace.

## WHAT'S INCLUDED.

- Burning Logs
- Single Burner
- Black Glass Panel
- Ecomax Remote Control

## OPTIONAL EXTRAS.

- Mains Adaptor
- Wifi Kit
- Wall Switch
- Remote Control Wall Mount
- Domotica Control

## TECHNICAL INFO.

GAS TYPE	NG	LPG
HEAT INPUT (kW)	4.6	5.4
HEAT OUTPUT MAX (kW)	3.9	4.3
HEAT OUTPUT MIN (kW)	2.9	2.8
EFFICIENCY (%)*	84	80
FLUE SIZE (MM)	100/150	
ERP RATING	B	C

## ALSO AVAILABLE IN.



QUARTZ  
PAGE 68



TOURMALINE  
PAGE 72

## DIMENSIONS.

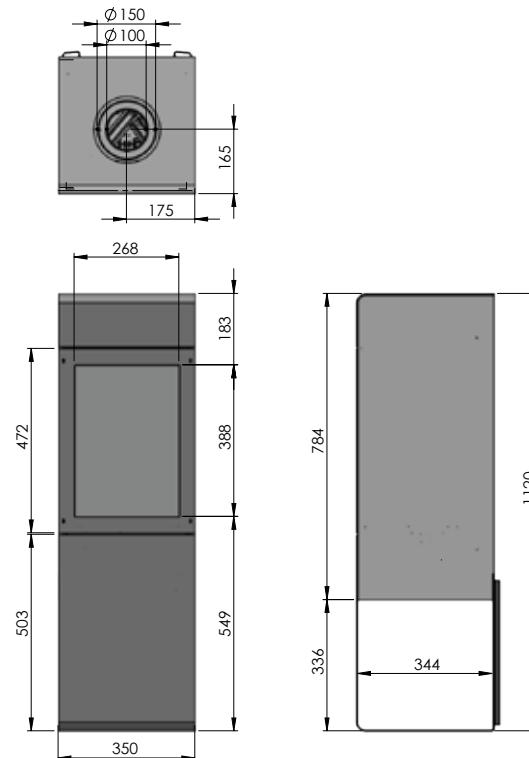





# TRIMLINE TOURMALINE.

The Tourmaline is not just a fireplace. The panoramic view of the flames, the burning logs and the LED fuel bed bring you into an atmospheric environment. The Tourmaline has beautifully rounded corners. In combination with its smooth lines, it turns out to be a beautiful model that is a joy to the eye. You have the option of leaving the bottom of the fireplace open for stools. But you can also add a unique and stylish statement.

## WHAT'S INCLUDED.

- Burning Logs
- Double Burner
- Lamel Chamber
- Ecomax Remote Control

## OPTIONAL EXTRAS.

- LED Glowing Fuel Bed
- Black Glass
- Wood Stool
- Fire Stool
- Anti-Reflective Glass
- Mains Adaptor
- Wifi Kit
- Wall Switch
- Remote Control Wall Mount
- Domotica Control

## TECHNICAL INFO.

GAS TYPE	NG	LPG
HEAT INPUT (kW)	6.8	6.5
HEAT OUTPUT MAX (kW)	5.3	5.2
HEAT OUTPUT MIN (kW)	3.7	3.8
EFFICIENCY (%)*	79	80
FLUE SIZE (MM)	100/150	
ERP RATING	C	C

## DIMENSIONS.

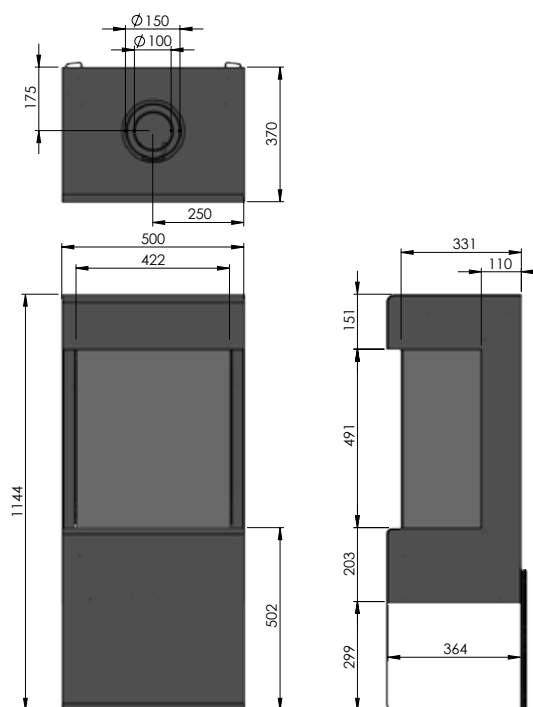

## ALSO AVAILABLE IN.



QUARTZ  
PAGE 68

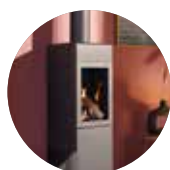

ZIRCON  
PAGE 72



# PANORAMIC.

Bring incredible ambience into your home with one of our stylish panoramic fireplaces. These stunning fires make an amazing centrepiece in any home. The three side fires allow a totally unrestricted view of the fire from all sides of the room at the touch of a button. Choose from six different size options, available in both natural gas and LPG.









# TL38P PANORAMIC.

The TL38 Panoramic fire is one of the smaller appliances within the range. With its realistic fuel bed and flame pattern, it makes a perfect choice for smaller properties. The three side fires allow a totally unrestricted view of the fire from all sides of the room at the touch of a button.

## WHAT'S INCLUDED.

- High Definition Logs
- Single Burner
- Lamel Chamber
- Ecomax Remote Control
- Convection Vents
- Adjustable Legs
- Gas Control Box

## OPTIONAL EXTRAS.

- Pebbles
- WiFi Kit
- Anti-Reflective Glass
- Remote Control Wall Mount
- Wall Switch
- Mains Adaptor
- Domotica Control

## TECHNICAL INFO.

GAS TYPE	NG	LPG
HEAT INPUT (kW)	6.4	6.2
HEAT OUTPUT MAX (kW)	5.2	5.2
HEAT OUTPUT MIN (kW)	2.8	2.5
EFFICIENCY (%)*	82	84
FLUE SIZE (MM)	100/150	
ERP RATING	B	B

## DIMENSIONS.

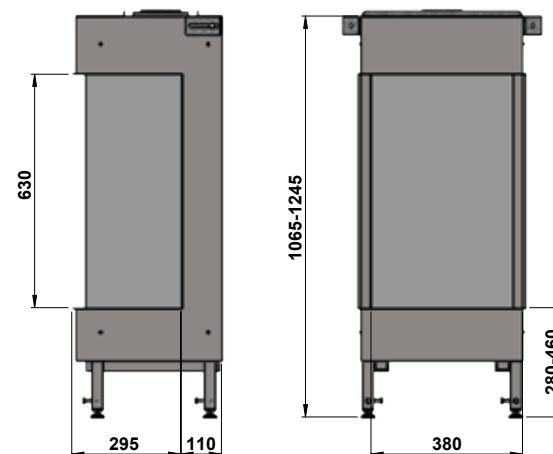
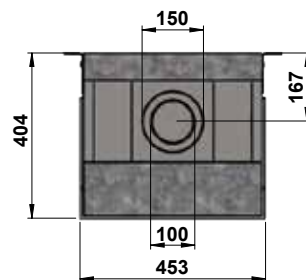

## ALSO AVAILABLE IN.



TRIMLESS  
PAGE 8



QUARTZ  
PAGE 68



CORNER  
PAGE 44



# TL63BL PANORAMIC.

The TL63BL Panoramic allows you to enjoy the beautiful and stylish ambiance created by the dancing flames. These stunning fires make an amazing centerpiece in any home. The balanced flue panoramic gas fire incorporates the latest burning log technology. This innovative feature is so realistic it cannot be distinguished from a natural living fire. With the addition of the optional glowing fuel bed, it creates a beautiful warm ambience!

## WHAT'S INCLUDED.

- Burning Logs
- Double Burner
- Flat Steel Chamber
- Ecomax Remote Control
- Convection Vents
- Adjustable Legs
- Gas Control Box

## OPTIONAL EXTRAS.

- Black Glass Panel
- Ceramic Chamber Lining
- Reeded Chamber Lining
- WiFi Kit
- Anti-Reflective Glass
- Remote Control Wall Mount
- Wall Switch
- Mains Adaptor
- Domotica Control

## TECHNICAL INFO.

GAS TYPE	NG	LPG
HEAT INPUT (kW)	9.5	11.2
HEAT OUTPUT MAX (kW)	7.5	8.8
HEAT OUTPUT MIN (kW)	3.2	2.8
EFFICIENCY (%)*	80	80
FLUE SIZE (MM)	130/200	
ERP RATING	B	B

## DIMENSIONS.

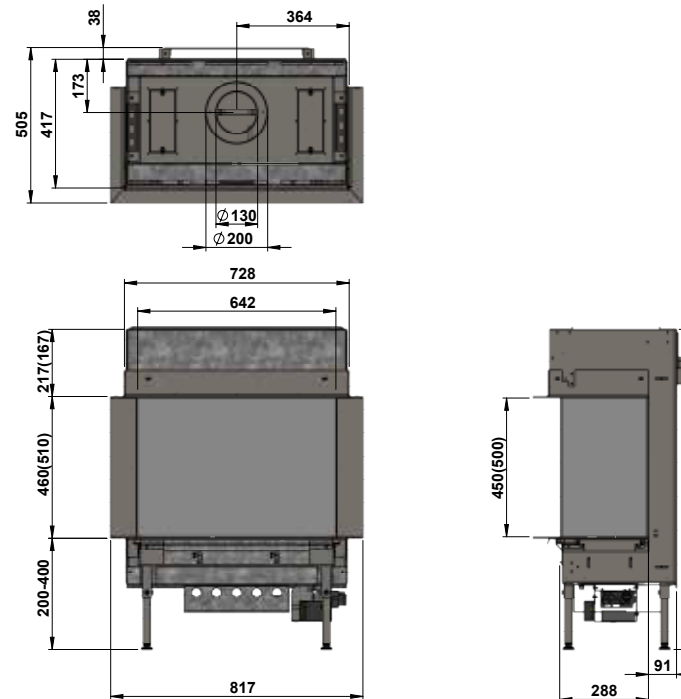

## ALSO AVAILABLE IN.



TRIMLESS  
PAGE 12



CORNER  
PAGE 46







# TL83P PANORAMIC.

Warmth at the touch of a button with the TL83 Panoramic, this balanced flue panoramic incorporates the latest burning log technology, the innovative feature is so realistic it cannot be distinguished from a natural living fire. With the addition of the optional glowing fuel bed it creates a beautiful warm ambience!

## WHAT'S INCLUDED.

- Burning Logs
- Double Burner
- Flat Steel Chamber
- Ecomax Remote Control
- Convection Vents
- Adjustable Legs
- Gas Control Box

## OPTIONAL EXTRAS.

- Black Glass Panel
- Interior Grey Chamber
- Black Groove Chamber
- LED Glowing Fuel Bed
- WiFi Kit
- Anti-Reflective Glass
- Remote Control Wall Mount
- Wall Switch
- Mains Adaptor
- Wall Bracket
- Domotica Control

## TECHNICAL INFO.

GAS TYPE	NG	LPG
HEAT INPUT (kW)	11.5	11.9
HEAT OUTPUT MAX (kW)	9.4	9.8
HEAT OUTPUT MIN (kW)	2.6	2.6
EFFICIENCY (%)*	82	82
FLUE SIZE (MM)	130/200	
ERP RATING	B	B

## DIMENSIONS.

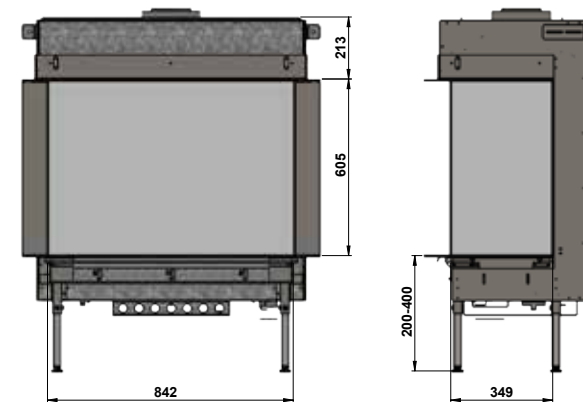
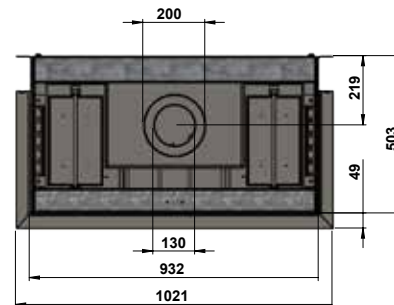

## ALSO AVAILABLE IN.

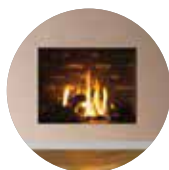

TRIMLESS  
PAGE 18



TUNNEL  
PAGE 34



CORNER  
PAGE 48

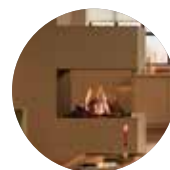

ROOM DIVIDER  
PAGE 62



# TL100P PANORAMIC.

The TL100 Panoramic is one of six stunning panoramic fires within the collection. These three sided fires allow a totally unrestricted view of the fire from all sides of the room at the touch of a button.

## WHAT'S INCLUDED.

- High Definition Logs
- Double Burner
- Lamel Chamber
- Ecomax Remote Control
- Convection Vents
- Adjustable Legs
- Gas Control Box

## OPTIONAL EXTRAS.

- Pebbles
- Carrara
- Basalt
- Black Glass Panel
- WiFi Kit
- Anti-Reflective Glass
- Remote Control Wall Mount
- Wall Switch
- Mains Adaptor
- Domotica Control
- Wide Trims

## TECHNICAL INFO.

GAS TYPE	NG	LPG
HEAT INPUT (kW)	11.2	9.7
HEAT OUTPUT MAX (kW)	9.4	8.1
HEAT OUTPUT MIN (kW)	2.9	3.6
EFFICIENCY (%)*	84	84
FLUE SIZE (MM)	130/200	
ERP RATING	B	B

## DIMENSIONS.

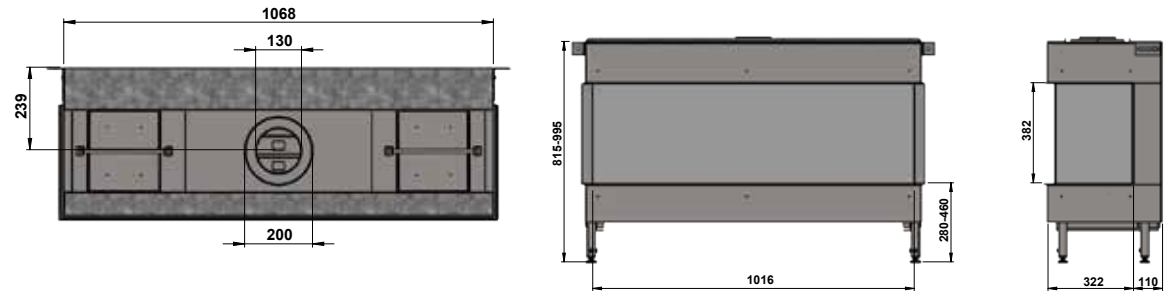

## ALSO AVAILABLE IN.



TRIMLESS  
PAGE 20



SILHOUETTE  
PAGE 22

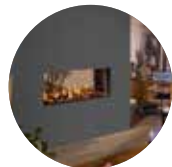

TUNNEL  
PAGE 36



CORNER  
PAGE 50





# TL120P PANORAMIC.

The TL120 Panoramic allows you to enjoy the beautiful and stylish ambiance created by the dancing flames. These stunning fires make an amazing centerpiece in any home. This three-sided fire allows a totally unrestricted view of the fire from all sides of the room at the touch of a button.

## WHAT'S INCLUDED.

- High Definition Logs
- Double Burner
- Lamel Chamber
- Ecomax Remote Control
- Convection Vents
- Adjustable Legs
- Gas Control Box

## OPTIONAL EXTRAS.

- Pebbles
- Carrara
- Basalt
- Black Glass Panel
- WiFi Kit
- Anti-Reflective Glass
- Remote Control Wall Mount
- Wall Switch
- Mains Adaptor
- Domotica Control
- Wide Trims

## TECHNICAL INFO.

GAS TYPE	NG	LPG
HEAT INPUT (kW)	13.1	9.9
HEAT OUTPUT MAX (kW)	10.9	8.1
HEAT OUTPUT MIN (kW)	2.5	2.0
EFFICIENCY (%)*	83	82
FLUE SIZE (MM)	130/200	
ERP RATING	B	B

## DIMENSIONS.

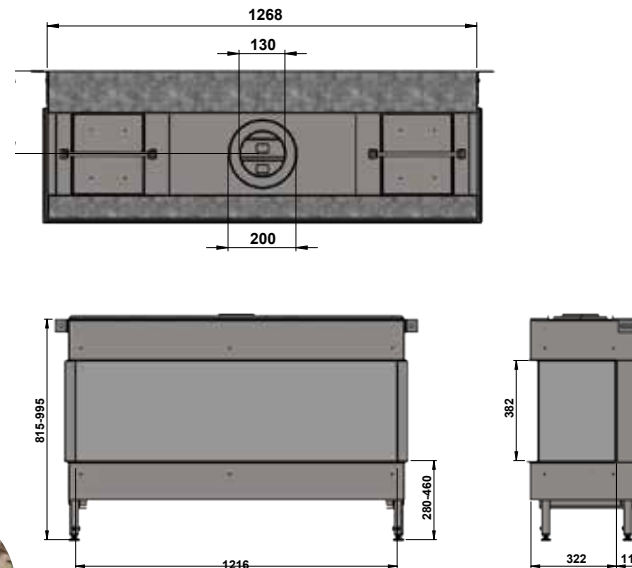

## ALSO AVAILABLE IN.

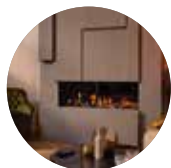

TRIMLESS  
PAGE 24

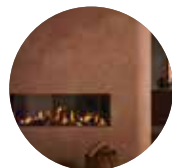

TUNNEL  
PAGE 38

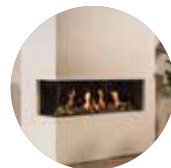

CORNER  
PAGE 52



# TL140P PANORAMIC.

The 140 Panoramic is the largest of the 6 panoramic fires within the Vision Trimline collection. These stunning 3 sided fires allow a totally unrestricted view of the fire from all sides of the room at the touch of a button.

## WHAT'S INCLUDED.

- High Definition Logs
- Double Burner
- Lamel Chamber
- Ecomax Remote Control
- Convection Vents
- Adjustable Legs
- Gas Control Box

## OPTIONAL EXTRAS.

- Pebbles
- Carrara
- Basalt
- Black Glass Panel
- WiFi Kit
- Anti-Reflective Glass
- Remote Control Wall Mount
- Wall Switch
- Mains Adaptor
- Domotica Control
- Wide Trims

## TECHNICAL INFO.

GAS TYPE	NG	LPG
HEAT INPUT (kW)	14.5	12.4
HEAT OUTPUT MAX (kW)	12.0	10.6
HEAT OUTPUT MIN (kW)	3.0	3.0
EFFICIENCY (%)*	83	86
FLUE SIZE (MM)	130/200	
ERP RATING	B	B

## DIMENSIONS.

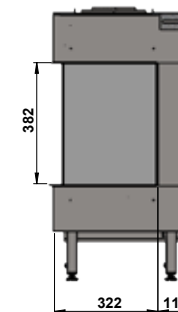
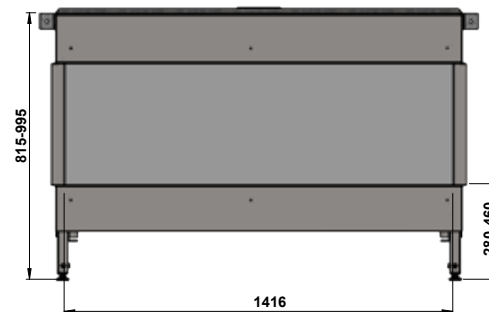
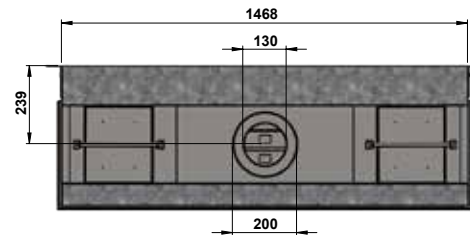

## ALSO AVAILABLE IN.

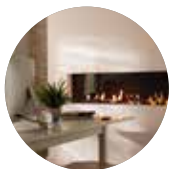

TRIMLESS  
PAGE 26

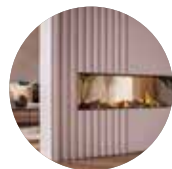

TUNNEL  
PAGE 40



CORNER  
PAGE 54

---

# DISCOVER THE POSSIBILITIES WITH THE TL70SL.

With an innovative, versatile design the compact TL70sl is easy to install and simple to service. The TL70SL can be wall mounted and installed directly to any internal outside facing wall.

One of the biggest advantages is that there is minimal building work required and with an output of 3.8kW and an impressive efficiency rating of B, the TL70sl will fit perfectly with virtually all interiors with sleek lines for a contemporary living statement.

The TL70sl utilises the same features as the other appliances within the range. The TL70 is remotely operated and to alleviate the need for batteries a mains adaptor is supplied as standard.







# TL70SL.

With an innovative, versatile design the compact TL70SL is easy to install & simple to service. It can be wall-mounted & installed directly to any internal outside-facing wall.

## WHAT'S INCLUDED.

- High Definition Logs
- Lamel Chamber
- Ecomax Remote Control
- Wall Terminal
- Mains Adaptor
- Terminal Flue Guard

## OPTIONAL EXTRAS.

- Vermiculite Chamber Upper/Lower
- Black Glass Panel
- Vermiculite Panels
- WiFi Kit
- Anti-Reflective Glass
- Remote Control Wall Mount
- Wall Switch
- Domotica Control

## TECHNICAL INFO.

GAS TYPE	NG	LPG
HEAT INPUT (kW)	4.5	4
HEAT OUTPUT MAX (kW)	3.8	3.3
HEAT OUTPUT MIN (kW)	2.8	2.0
EFFICIENCY (%)*	84	83
FLUE SIZE (MM)	100/150	
ERP RATING	B	B

## DIMENSIONS.

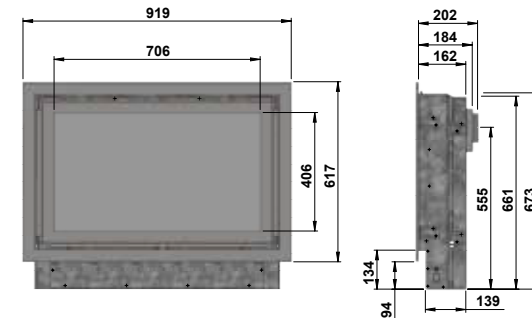
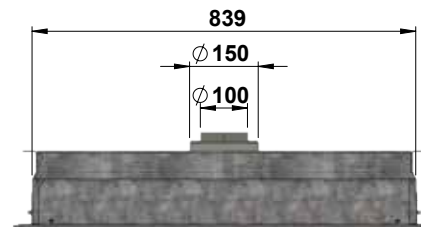

## ALSO AVAILABLE IN.



IHB  
PAGE 92



PANACEA  
PAGE 94



HAMPTON  
PAGE 96



RADLEY  
PAGE 98



RICO  
PAGE 100





## TL70SL WITH INTEGRATED HEAT BOX.

When the TL70SL is installed with our new bespoke Integrated Heat Box (IHB) it allows you to construct the installation from combustible materials making the fire a versatile choice in most modern building applications.

The use of the integrated heat box allows the appliance to be installed in situations where combustible surfaces or materials would or may hinder the installation given the risk of heat and allows quicker access for service and maintenance.

- Easy to install & simple to service
- Can be fitted with the use of combustible materials\* when installing with the Integrated Heat Box
- Slimline appliance only 155mm depth
- Can be wall mounted or installed within a suite
- Can be installed directly to any internal outside facing wall
- Energy class B – 84% efficient
- Can be installed into a cavity wall
- Realistic log effect
- Comes complete with mains adaptor

\*Please refer to installation instructions when fitting with or without the IHB

### ALSO AVAILABLE IN.



TL70SL  
PAGE 90



PANACEA  
PAGE 94



HAMPTON  
PAGE 96



RADLEY  
PAGE 98



RICO  
PAGE 100



# TL70SL PANACEA.

No chimney breast? No problem! The Panacea suite is not just an aesthetically balanced fireplace with its defining proportions and contrasting tones of natural Portuguese limestone and honed granite; the innovative design allows it to be installed against a flat wall, with no need for a chimney breast. The complete appliance is housed within the body of the fireplace meaning it can be installed in almost any room with minimal fuss.

## WHAT'S INCLUDED.

- High Definition Logs
- Lamel Chamber
- Ecomax Remote Control
- Mains Adaptor
- Wall Terminal
- Terminal Flue Guard

## OPTIONAL EXTRAS.

- Vermiculite Chambers Upper/Lower
- Vermiculite Panels
- Black Glass Panel
- WiFi Kit
- Anti-Reflective Glass
- Remote Control Wall Mount
- Wall Switch
- Domotica Control

## TECHNICAL INFO.

GAS TYPE	NG	LPG
HEAT INPUT (kW)	4.5	5
HEAT OUTPUT MAX (kW)	3.8	3.3
HEAT OUTPUT MIN (kW)	2.8	2
EFFICIENCY (%)*	84	83
FLUE SIZE (MM)	100/150	
ERP RATING	B	B

## DIMENSIONS.

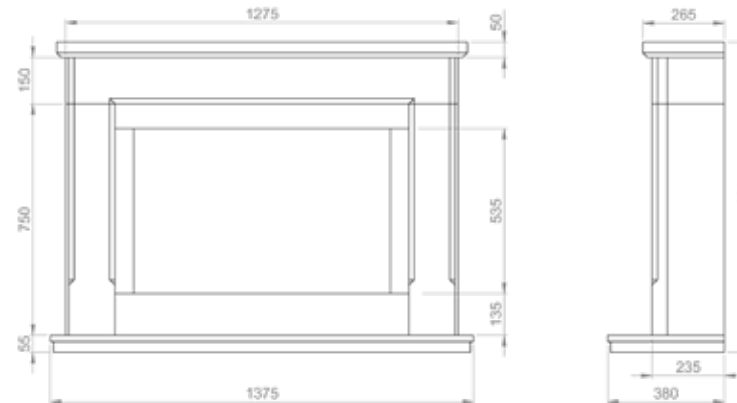

## ALSO AVAILABLE IN.



TL70SL  
PAGE 90



IHB  
PAGE 92



HAMPTON  
PAGE 96



RADLEY  
PAGE 98



RICO  
PAGE 100





# TL70SL HAMPTON.

The Hampton is a stunning frame designed exclusively to add a touch of elegance to the TL70SL fire, with contrasting tones of black nickel and chromed steel. Here, simplicity is key, creating a true statement piece that will draw focus to any room.

## WHAT'S INCLUDED.

- High Definition Logs
- Lamel Chamber
- Ecomax Remote Control
- Mains Adaptor
- Wall Terminal
- Terminal Flue Guard

## OPTIONAL EXTRAS.

- Vermiculite Chambers Upper/Lower
- Vermiculite Panels
- Black Glass Panel
- WiFi Kit
- Anti-Reflective Glass
- Remote Control Wall Mount
- Wall Switch
- Domotica Control

## TECHNICAL INFO.

GAS TYPE	NG	LPG
HEAT INPUT (kW)	4.5	5
HEAT OUTPUT MAX (kW)	3.8	3.3
HEAT OUTPUT MIN (kW)	2.8	2
EFFICIENCY (%)*	84	83
FLUE SIZE (MM)	100/150	
ERP RATING	B	B

## DIMENSIONS.

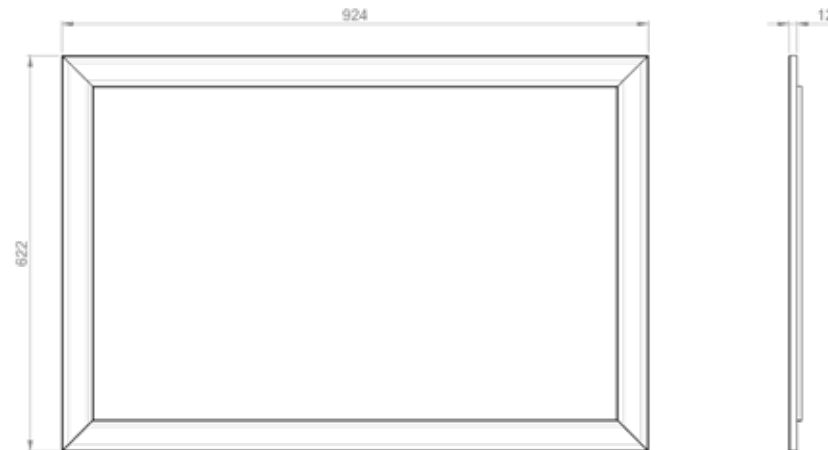

## ALSO AVAILABLE IN.



TL70SL  
PAGE 90



IHB  
PAGE 92



PANACEA  
PAGE 94



RADLEY  
PAGE 98



RICO  
PAGE 100



# TL70SL RADLEY.

Add something extra special to your TL70SL with the Radley suite. It has been designed exclusively for the TL70SL, this suite is one of the most niche suites on the market with its elegant bench.

## WHAT'S INCLUDED.

- High Definition Logs
- Lamel Chamber
- Ecomax Remote Control
- Mains Adaptor
- Wall Terminal
- Terminal Flue Guard

## OPTIONAL EXTRAS.

- Vermiculite Chambers Upper/Lower
- Vermiculite Panels
- Black Glass Panel
- WiFi Kit
- Anti-Reflective Glass
- Remote Control Wall Mount
- Wall Switch
- Domotica Control

## TECHNICAL INFO.

GAS TYPE	NG	LPG
HEAT INPUT (kW)	4.5	5
HEAT OUTPUT MAX (kW)	3.8	3.3
HEAT OUTPUT MIN (kW)	2.8	2
EFFICIENCY (%)*	84	83
FLUE SIZE (MM)	100/150	
ERP RATING	B	B

## DIMENSIONS.

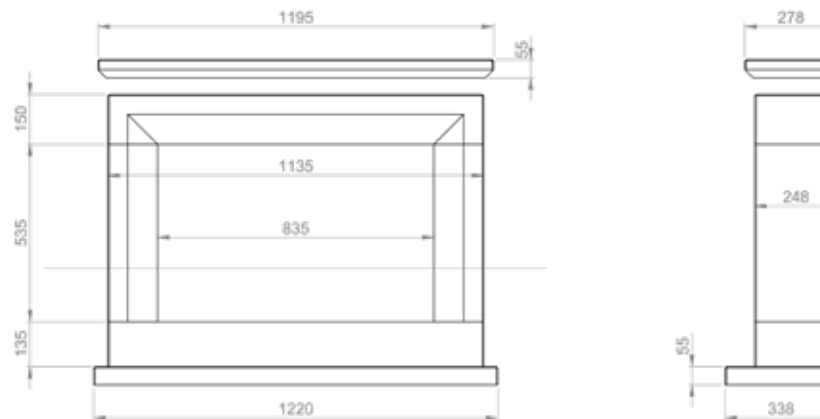

## ALSO AVAILABLE IN.



TL70SL  
PAGE 90



IHB  
PAGE 92



PANACEA  
PAGE 94



HAMPTON  
PAGE 96



RICO  
PAGE 100





# TL70SL RICO.

Designed exclusively for our TL70SL this quirky mantle features an Agean Limestone mantle combined beautifully with a honed granite bench which perfectly frames the stunning flames.

## WHAT'S INCLUDED.

- High Definition Logs
- Lamel Chamber
- Ecomax Remote Control
- Mains Adaptor
- Wall Terminal
- Terminal Flue Guard

## OPTIONAL EXTRAS.

- Vermiculite Chambers Upper/Lower
- Vermiculite Panels
- Black Glass Panel
- WiFi Kit
- Anti-Reflective Glass
- Remote Control Wall Mount
- Wall Switch
- Domotica Control

## TECHNICAL INFO.

GAS TYPE	NG	LPG
HEAT INPUT (kW)	4.5	4
HEAT OUTPUT MAX (kW)	3.8	3.3
HEAT OUTPUT MIN (kW)	2.8	2
EFFICIENCY (%)*	84	83
FLUE SIZE (MM)	100/150	
ERP RATING	B	B

## DIMENSIONS.

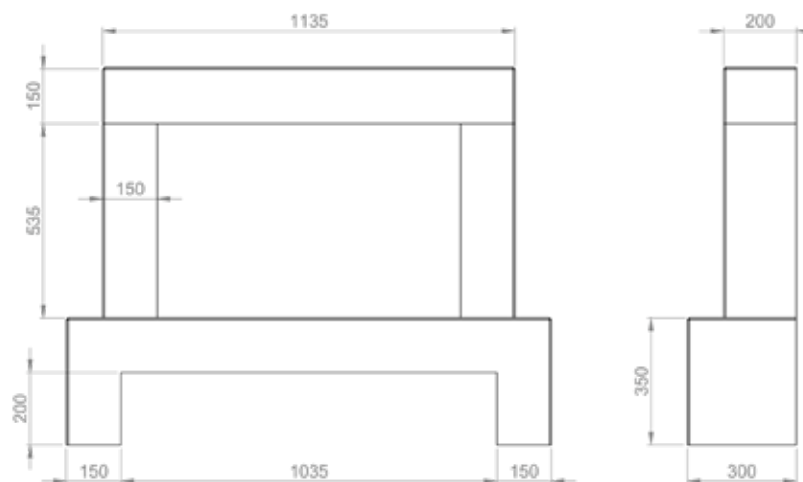

## ALSO AVAILABLE IN.



TL70SL  
PAGE 90



IHB  
PAGE 92



PANACEA  
PAGE 94



HAMPTON  
PAGE 96



RADLEY  
PAGE 98

---

# UNIQUE STYLING.

Vision Trimline fires offer a sense of true minimalist beauty. However, if your home style dictates, there can sometimes be a requirement for a little more flare, even extravagance!

To address this, we have created an option to combine any standard\* mantel with the TL73H and TL63 giving you more choice to create your very own unique fireplace.

There are no limits to your creativity with the TL73H and TL63 option, we have put together a collection of ideas on pages 104 to 107 for inspiration.

\*Ask your approved stockists for details













# CONVENTIONAL THINKING.

If your home does feature a conventional brick chimney and you wish to utilise this, then we have that covered with our TL60CF appliance. Like our balanced flued appliances, the TL60CF can be fitted trimless, with the classically styled Woodbury fireplace suite, or with a variety of mantels to create a truly unique focal point to your living space.









# TL60CF TRIMLESS

If your home features a conventional brick chimney and you wish to utilise this, then we have that covered with our TL60CF appliance. Like our balanced flue appliances, the TL60CF can be fitted trimless, with the classically styled Woodbury fireplace suite designed exclusively for the TL60CF, or with a variety of fireplace mantels to create a truly unique focal point to your living space.

## WHAT'S INCLUDED.

- High Definition Logs
- Flat Steel Chamber
- Ecomax Remote Control
- Adjustable Legs

## OPTIONAL EXTRAS.

- Black Glass Panel
- Anti-Reflective Glass
- Wall Switch
- Remote Control Wall Mount

## TECHNICAL INFO.

GAS TYPE	NG	LPG
HEAT INPUT (kW)	6.8	6.4
HEAT OUTPUT MAX (kW)	5.1	4.8
HEAT OUTPUT MIN (kW)	2.5	2.9
EFFICIENCY (%)*	75	76
FLUE SIZE (MM)	100	
ERP RATING	D	D

## DIMENSIONS.

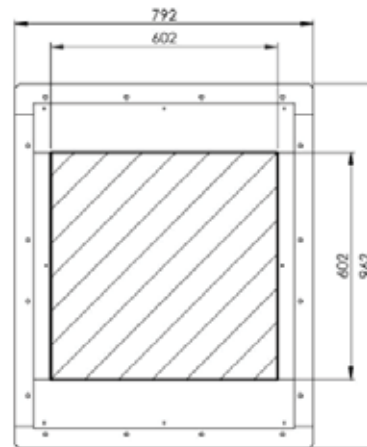
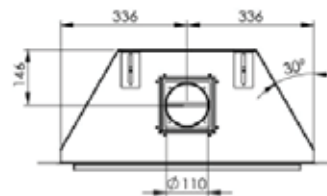

## ALSO AVAILABLE IN.



WOODBURY  
PAGE 112



TRIMMED  
PAGE 118







# TL60CF WOODBURY SUITE

If your home features a conventional brick chimney and you wish to utilise this, then we have that covered with our TL60cf appliance. Like our balanced flue appliances, the TL60cf can be fitted trimless, with the classically styled Woodbury fireplace suite designed exclusively for the TL60CF, or with a variety of fireplace mantels to create a truly unique focal point to your living space.

## WHAT'S INCLUDED.

- High Definition Logs
- Flat Steel Chamber
- Ecomax Remote Control
- Adjustable Legs

## OPTIONAL EXTRAS.

- Black Glass Panel
- Anti-Reflective Glass
- Wall Switch
- Remote Control Wall Mount

## TECHNICAL INFO.

GAS TYPE	NG	LPG
HEAT INPUT (kW)	6.8	6.4
HEAT OUTPUT MAX (kW)	5.1	4.8
HEAT OUTPUT MIN (kW)	2.5	2.9
EFFICIENCY (%)*	75	76
FLUE SIZE (MM)	100	
ERP RATING	D	D

## DIMENSIONS.

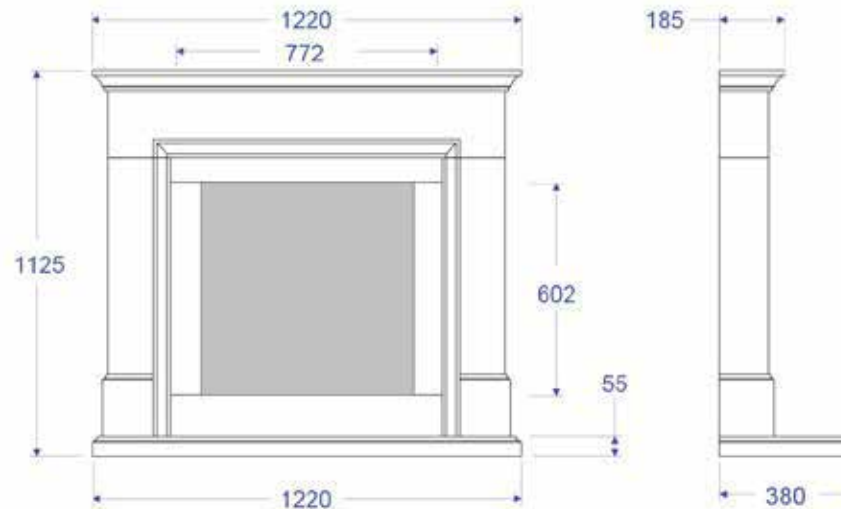

## ALSO AVAILABLE IN.



TRIMLESS  
PAGE 110



TRIMMED  
PAGE 118













# TECHNOLOGY.

## EVERYTHING YOU NEED IN ONE PACKAGE

**Ecomax remote control** - this sleek designed handset features a thermostatic control countdown timer to automatically turn off the fire, and an Ecomax button, allowing adjustment of the flames to regulate room temperature resulting in a 40% energy saving.

**Adjustable legs** - allowing you to easily install the fire at your desired height without the need for further, unnecessary building work.

**Control access door** - a neat, gloss finish, access system to allow access to the manual fire controls.

**Convection vents** - two of these are supplied with each fire to allow convected hot air from the chimney into your room.

## DOUBLE BURNER (DB) FEATURE

With the exception of the TL38, TL46, TL60CF AND TL63C/P models, all other Vision Trimline fires are equipped with an innovative double burner system. This clever feature staggers the flame pattern in two rows and gives an extra sense of depth and realism whilst offering a more economical way to use your fire. At the touch of a button the front burner row remains active whilst the rear burner row diminishes, giving unparalleled visual effect with a reduction of 40% of the heat output. Used in combination with the Ecomax remote control can result in the benefit of reduced running costs of up to 60%.

---

## GO WI-FI FOR MAXIMUM CONTROL

Introducing the latest optional upgrade option for Vision Trimline fires, the Myfire app uses wireless technology that connects the fire to your home Wi-Fi network. You can now take control using your smartphone or tablet with features such as:

- Temperature adjustment and thermostatic control
- Flame pattern adjustment and animated wave profiles
- Individual user profiles
- Countdown timer
- Weekly programming



## ANTI-REFLECTIVE GLASS

Anti-reflective glass (ARG) which is available on many Vision Trimline models is a premium feature that allows you to maximise your experience of the beautiful flames giving the appearance of an open fire whilst having the convenience of a gas appliance. This clever feature gives the illusion that there is no glass between the fire and you, creating an even more authentic experience.

## BURNING LOGS TECHNOLOGY

TL63, TL83, Tourmaline and Zircon models incorporate the latest burning logs technology to recreate the most authentic, realistic looking flame ever. Combined with high definition, ultra realistic ceramic logs, this innovative feature creates a fire so realistic it cannot be distinguished from a natural, living fire. For the ultimate in warm ambiance, the optional LED glowing fuel bed creates a subtle, relaxing impression of gently burning embers.

---

# INTERIOR STYLING & FUELBED OPTIONS.

For that extra WOW factor, why not choose to upgrade to a black mirrored glass lining for your fire chamber and add a reflection to the fuel bed and flames to give a remarkable effect of added depth and detail. If burning logs is not the look you are going for, then perhaps you would be more interested in an alternative fuel bed for your fire. The collection features a range of stunning options to choose from.

---

Lamel Chamber Panel



Black Groove Chamber Panel

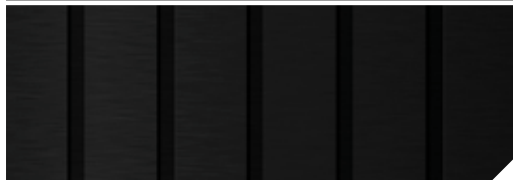

Black Glass Panel



Vermiculite Chamber Panel



Interior Grey Brick Chamber Panel



Fire Brick Chamber Panel



Reeded Chamber Panel





High Definition Logsets



Carrara Stones



White Pebbles



Basalt



## TL70SL UPGRADE OPTIONS.

For that extra WOW factor, there is also an option to upgrade to a black glass lining within the combustion chamber which offers a remarkable effect of added depth and detail. Other available upgrades also include Wi-Fi, vermiculite interior lining and alternative frame options.

### BLACK GLASS UPGRADE.



### VERMICULITE BRICKS UPGRADE.



# FLUE SYSTEMS.



All Vision Trimline fires (excluding the TL60CF) use a specialised double wall concentric flue system. The THC-CC system is an obligatory and integral part of the complete combustion system and must be used when installing the fire. THC-CC is made of high quality 0.5mm thick stainless steel AISI 316 inner and AISI 304 outer-liner.

A wide range of flue/chimney components allows for easy installation when terminating through the wall or the roof in an existing chimney or a dedicated fabrication. Please consult your nearest dealer for more details. The THC-CC system is approved according to CE in combination with all Vision Trimline balanced flue gas fires.

New to the Vision Trimline range is the DECO concentric flue system. Elegant connecting pipes with no visible locking bands available in black coated stainless steel. Both the design and ease of installation are of a very high standard. The connection of the various sections and elements is carried out by means of a click connection with the cam spring. Turn the flue to the correct position and when you hear the "click" it is already securely attached. It has never been so easy to quickly install a beautiful connecting pipe!

The DECO system is the first and only system that works with this unique click connection and is made of high-quality stainless steel material and is resistant to high temperatures and flue gases.



UNIQUE  
**BURNING**  
LOGS  
TECHNOLOGY.

Available as standard on all TL63,  
TL83, Tourmaline and Zircon fires,  
including trimless, corner and  
panoramic models.

VISION  
trimline